



AUDIOVOX®
ELECTRONICS CORP.

OWNER'S MANUAL

DVD-220



COMPACT
disc
DIGITAL AUDIO

Welcome to purchase AUDIOVOX DVD players. For perfect operation and security, read the manual carefully and keep it for future reference.

A. SAFETY PRECAUTIONS

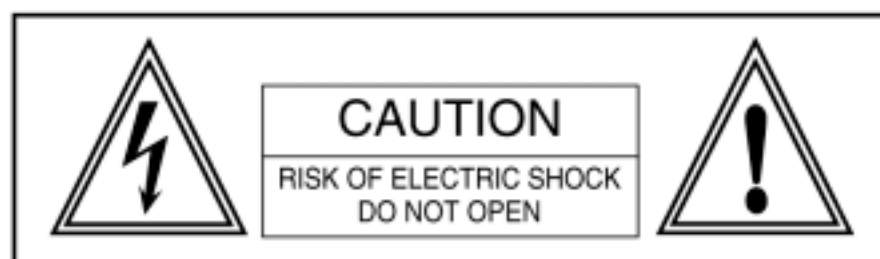

- The lightning flash with arrowhead symbol within an equilateral triangle is intended to alert the user to the presence of "uninsulated" dangerous voltage" within the product's enclosure that may be of sufficient magnitude to constitute a risk of electric shock to persons.



- The exclamation point within an equilateral triangle is intended to alert the user to the presence of important operating and maintenance (servicing) instructions in the literature accompanying the product.

WARNING: To reduce the risk of fire or electric shock, do not expose this appliance to rain or moisture. Dangerous high voltages are present inside the enclosure. Do not open the cabinet.

CAUTION: To prevent electric shock, match wide blade plug to wide slot, fully insert.

CAUTION: The unit employs a laser system. To ensure the proper use of the unit, read this manual carefully and keep it for future reference. If the unit requires servicing, contact the seller or our service center- see "troubleshooting". To prevent direct exposure to the laser radiation, do not open the cabinet. In visible laser radiation when the cabinet is opened or the interlocks are defeated. Do not stare into the laser beams. Use of any controls, adjustments, or procedures other than those specified herein may result in hazardous radiation exposure.

WARNING: Any change or modification to the unit, not expressly approved by **AUDIOVOX** or its authorized parties, could void user's authority to operate the unit.

B. IMPORTANT SAFETY INSTRUCTIONS

- 1) Read these instructions.
- 2) Keep these instructions.
- 3) Heed all warnings.
- 4) Follow all instructions.
- 5) Do not use this apparatus near water.
- 6) Clean only with dry cloth.
- 7) Do not block any ventilation openings. Install in accordance with the manufacturer's instructions.
- 8) Do not install near any heat sources such as radiators, heat registers, stoves, or other apparatus (including amplifiers) that produce heat.
- 9) Do not defeat the safety purpose of the polarized or grounding-type plug. A Polarized plug has two blades with one wider than the other. A grounding-type plug has two blades and a third grounding prong. The wide blade or the third prong are provided for your safety. If the provided plug does not fit into your outlet, consult an electrician for replacement of the obsolete outlet.
- 10) Protect the power cord from being walked on or pinched particularly at plugs, convenience receptacles, and the point where they exit from the apparatus.
- 11) Only use attachments/accessories specified by the manufacturer.
- 12) Unplug this apparatus during lightning storms or when unused for long periods of time.
- 13) Refer all servicing to qualified service personnel. Servicing is required when the apparatus has been damaged in any way, such as power-supply cord or plug is damaged, liquid has been spilled or objects have fallen into the apparatus, the apparatus has been exposed to rain or moisture, does not operate normally, or has been dropped.

This product incorporates copyright protection technology that is protected by method claims of certain U.S. patents and other intellectual property rights owned by Macrovision Corporation and other rights owners. Use of this copyright protection technology must be authorized by Macrovision Corporation, and is intended for home and other limited viewing uses only unless otherwise authorized by Macrovision Corporation. Reverse engineering or disassembly is prohibited.



TABLE OF CONTENTS

A. SAFETY PRECAUTIONS	1
B. IMPORTANT SAFETY	
INSTRUCTIONS	2
C. FEATURES	3
D. ABOUT MANUAL	4
E. PLAYABLE DISCS	4
F. TERMS FOR DISCS	5
G. BEFORE OPERATION	6
H. PRECAUTIONS FOR DISCS	6
I. PREPARATIONS BEFORE	
OPERATION	7
• CHECK ACCESSORIES	7
• USE REMOTE CONTROL	7
• FRONT PANEL	8
• DISPLAY	9
• REAR PANEL	9
• NAMES AND LAYOUT OF REMOTE	
CONTROLS	10
• CONNECTIONS	11-12
J. BASIC OPERATIONS	13
• TV/AUDIO SELECTION	13
• PLAY DISCS	13
• PAUSE	14
• OSD	14
• VOLUME CONTROL	16
• DVD MENU PLAY	17
• SELECT WITH NUMBER	
BUTTONS	17

K. PLAY DISCS IN	
VARIOUS WAYS	18
• AUDIO MODE	18
• MUTE	18
• FAST PLAY	19
• SLOW PLAY	19
• REPEAT PLAY	20
• SELECT SUBTITLES	21
• SELECT ANGLES	21
• TIME SEARCH	
AND REMAINING TIME	22
• BOOK MARK	23
• ZOOM PLAY	24
• PROGRAM PLAY	24
• SHUFFLE PLAY	25
• DIGEST PLAY	26
L. FUNCTION SETTING	27
• MENU SETTING	27-31
M. MP3 OPERATIONS	32
• PLAY DISCS	32
N. KODAK PICTURE CD PLAYBACK	33
O. OTHERS	34
• TROUBLESHOOTING	34
• TECHNICAL SPECIFICATIONS	35

C. FEATURES

1. OUTSTANDING SOUND QUALITY

Dolby Digital  system developed by Dolby Laboratories and DTS  developed by DTS Inc., features high quality which can be played in DVD or CD disc at home.

2. HIGH DEFINITION

The unit adopts MPEG2 coding format and brings the horizontal resolution over 500 lines.

3. UNIQUE FUNCTIONS

Multi-angle and multi-language bring unique trick functions. Parental lock makes it easy to control the content of discs.

4. SCREEN

Ordinary screen and wide screen (16:9) are available.

5. COMPATIBILITY

The unit can play DVD, CD, MP3, CD-R and CD-RW discs.

6. ZOOM

It can enlarge pictures twice or three or four times as large.

It can also shrink pictures 1/2, 1/3, or 1/4 as large.

7. 6-PICTURE DIGEST

It can look through the content of discs and select to play.

8. MULTI-FUNCTIONS

Fast forward, fast reverse, slow play, frame play, repeat play and program play.

9. TIME SEARCH

It can search a specific part on a disc, especially good for watching fiction movies.

10. CONTENT DISPLAY

Colored fluorescent display and English OSD, make the disc content clearer.



11. AUDIO OUTPUT

Analog audio output and coaxial digital audio output, can be connected with any amplifier to enjoy high quality sound effects.





D. ABOUT MANUAL

PRINCIPLES FOR WRITING

- This manual mainly introduces how to use the buttons on the remote control.
- You may operate the unit if the buttons on the unit have the same or similar names as to those on the remote control.
- The marks shown in the right chart are used in the manual.
- "⊘" may appear on the TV screen during operation. This icon means the function explained in the owner's manual is not available on that disc.

MARK	INDICATION
	functions of DVD
	functions of CD

E. PLAYABLE DISCS

TYPE	MARK	CONTENT	SIZE	PLAYING TIME
DVD		audio+video (motion pictures)	12cm	approx. 2hrs (single-side disc) approx. 4hrs (double-side disc)
			8cm	approx. 80mins (single-side disc) approx. 160mins (double-side disc)
			12cm	approx. 74mins
			8cm	approx. 20mins
CD [⊘] CD-R CD-RW		audio	12cm	approx. 74mins
MP3		audio	12cm	600mins
Kodak Picture CD		pictures	12cm	

Note: 1. Region codes for DVD disc are printed on the rear panel, only the disc with same code can be played.

2. This product complies with the Kodak Picture CD format and will display Kodak Picture CDs. The "Kodak Picture CD COMPATIBLE" logo is a trademark of Eastman Kodak Company and is used with permission.

F. TERMS FOR DISCS

• **TITLE**

The images or music of a DVD are divided into some units, among which title is the biggest one.

To a image in video software, title is movie; to a piece of music in audio software, it is music.

Each title has a indication number which makes it easy to locate.

• **CHAPTER**

It is smaller than title among the units of a DVD. A title is made up of several chapters, and each chapter has a number for search. But some discs may not have numbered chapters.

• **TRACK**

The music in a CD. Each track has a number for search.

STRUCTURE OF DVD

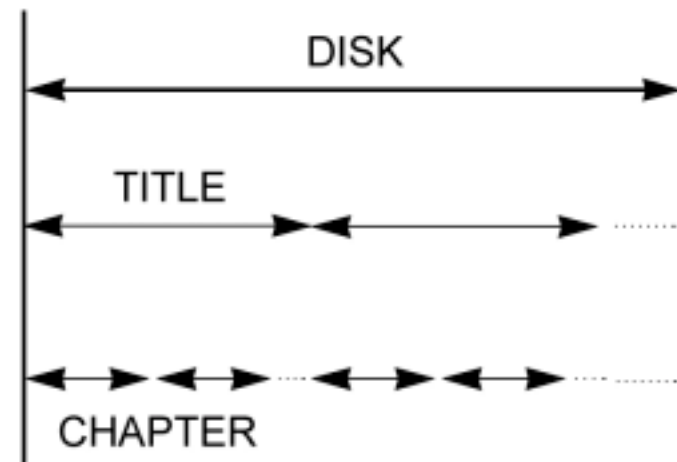

STRUCTURE OF CD

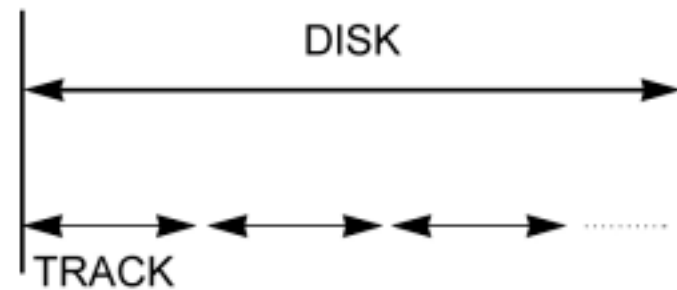

G. BEFORE OPERATION

SAFETY

- Before operation, check if the voltage of the unit is in line with the local voltage.
- Hold the plug to disconnect it from the mains outlet. Do not pull the power cord.
- When the plug of the unit is connected to the mains outlet, the unit will be still connected to AC even if the power is turned off.
- Disconnect the plug as soon as liquid or objects enter the unit. The unit can not be used until being checked by experts.
- Do not open the cabinet for laser rays employed by the unit may damage eyes. Any servicing should be done by qualified service personnel.

PLACEMENT

- Product intended for table top or top surface operation only.
- Never put the unit in direct sunlight or near heat sources.
- Put the unit horizontally, never put any heavy object on the unit.
- To protect the laser, do not put the unit where there is most dust. If there is dust on the laser, use a cleaning disc to clean it.
- Refer to the operation instructions of the cleaning disc you bought.

CONDENSATION

Water will appear on the pickup lens in the following cases:

- The unit is suddenly moved a cold place to a warm place.
- The unit is put in a room with a heater, or in the cold air from a air-conditioner.

- Use the unit in a humid place. In these cases, the unit can not work. Unload the disc and leave the unit on for about one hour to evaporate the water.

CLEANING

- Use soft cloth with a little neutral detergent to wipe the cabinet, panel and controls. Never use abrasive paper, polishing powder or solvent like alcohol and gasoline.

H. PRECAUTIONS FOR DISC

HANDLING DISC

- To keep the disc clean, do not touch the play sides of the disc.
- Do not attach paper or tape to the disc.



- Keep the disc away from direct sunlight or heat sources.
- Store the disc in a disc case after playback.

CLEANING DISC

- Before playback, wipe the disc outwards from the center with clean cloth.



- Do not use any type of solvent such as thinner, benzene, commercially available cleaners or antistatic spray.

I. PREPARATIONS BEFORE OPERATION

This part introduces the work to be done before operating the unit.

CHECK ACCESSORIES

Check if you have all the accessories after the carton is opened.

- ⌘ Audio cord 1 (4-terminal)
- ⌘ Video cord 1 (2-terminal)
- ⌘ Remote control 1
- ⌘ AAA batteries 2
- ⌘ Owner's manual 1

USE REMOTE CONTROL

1. Open the battery cover.

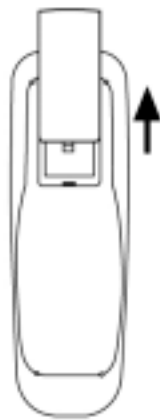

2. Insert two AAA batteries, make sure to match "+" and "-" on the batteries to marks inside the battery compartment.

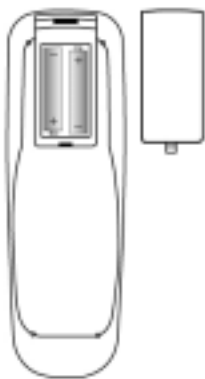

3. Close the battery cover.

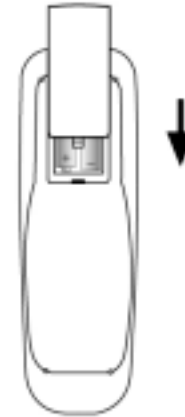

4. Point the remote control at the remote sensor, operate in the range of 7 meters and about 30° in each direction of the front of the remote sensor. Make sure there is no barrier between them.

Notes:

1. The batteries can last about 6 months generally.
Change the batteries if the remote control does not work.
2. If the remote control is not used for a long time, remove the batteries to prevent battery leakage.

I. PREPARATIONS BEFORE OPERATION

FRONT PANEL

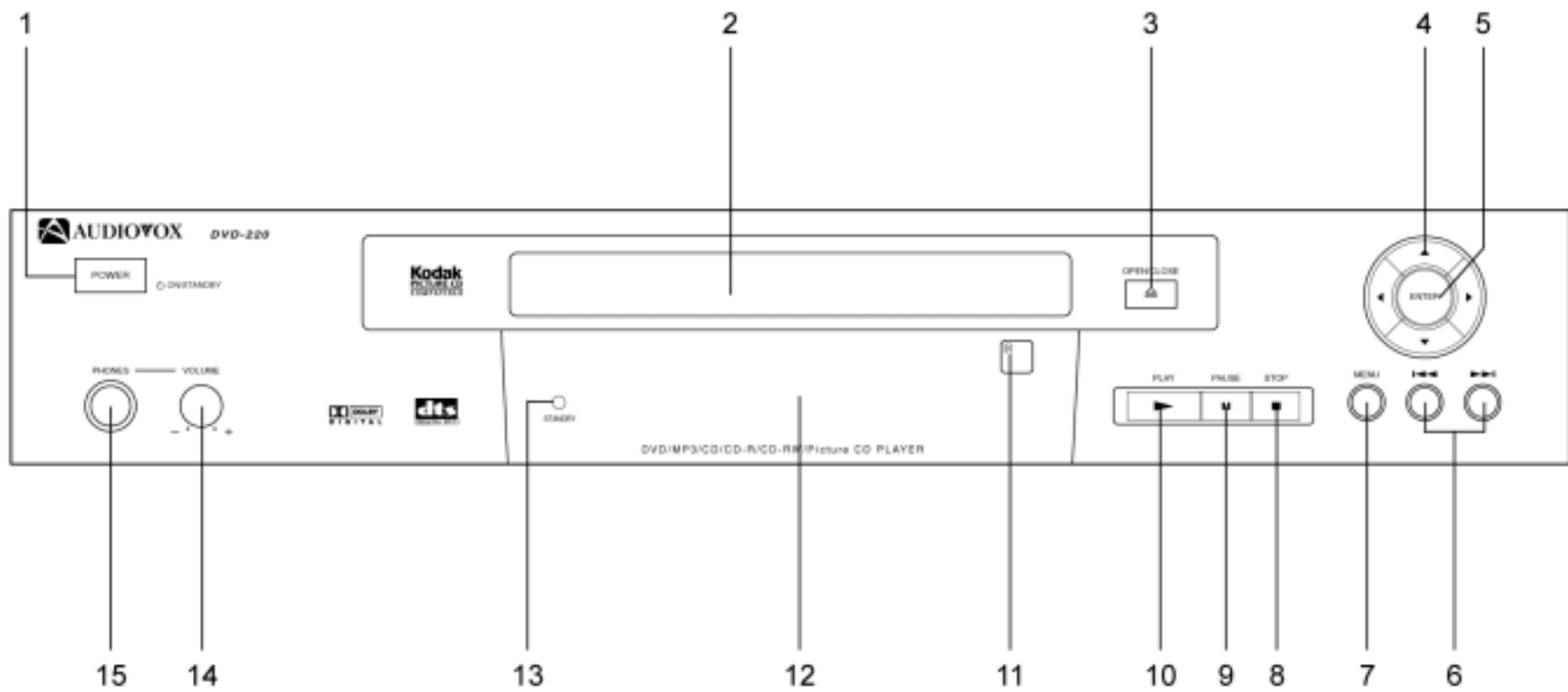

- | | |
|---------------------|---------------------|
| ① POWER | ⑨ PAUSE |
| ② DISC TRAY | ⑩ PLAY |
| ③ OPEN/CLOSE | ⑪ REMOTE SENSOR |
| ④ DIRECTION BUTTONS | ⑫ DISPLAY |
| ⑤ ENTER | ⑬ STANDBY INDICATOR |
| ⑥ PREV/NEXT SKIP | ⑭ PHONES LEVEL |
| ⑦ MENU | ⑮ PHONES JACK |
| ⑧ STOP | |

I. PREPARATIONS BEFORE OPERATION

DISPLAY

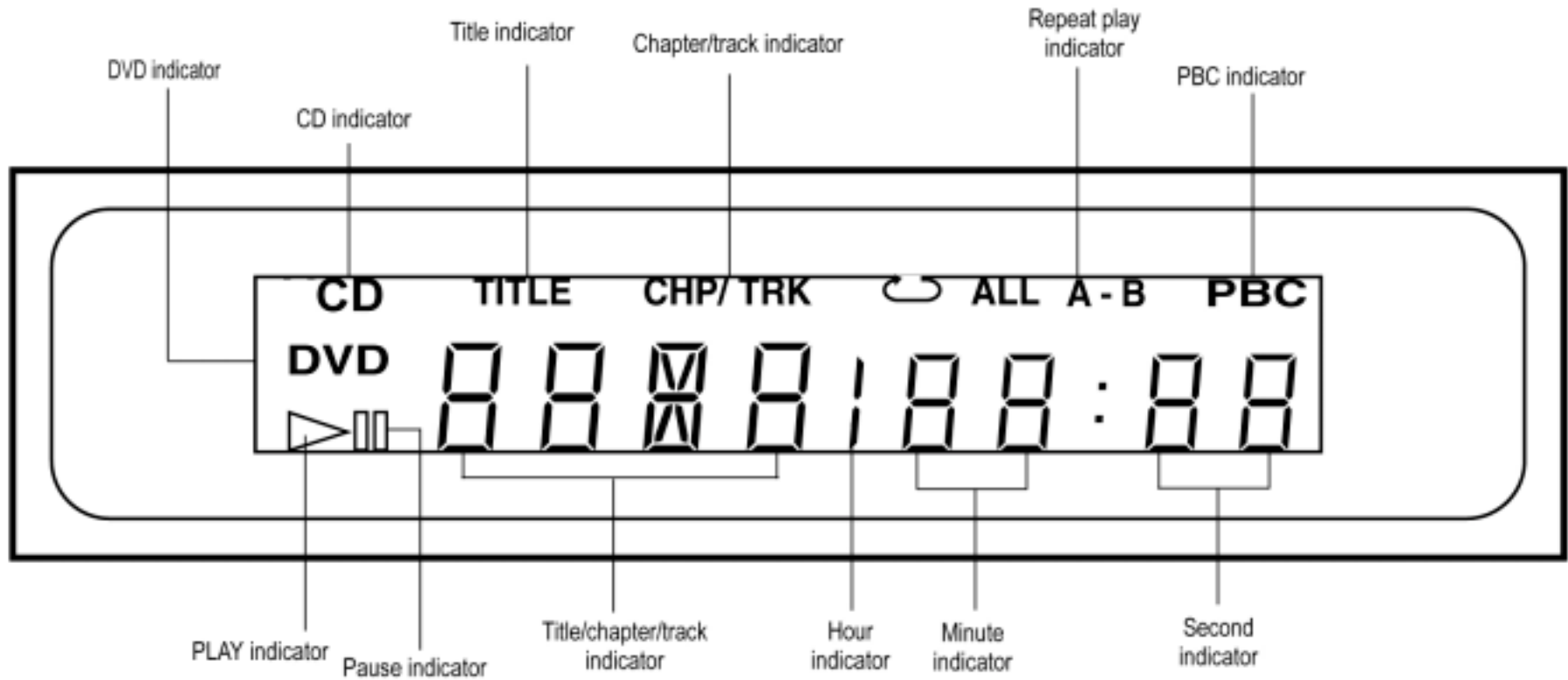

Push **DIMMER**, the brightness of the display is reduced by half, push it once more, the display becomes dark. Push the button again, the display resumes brightness.

REAR PANEL

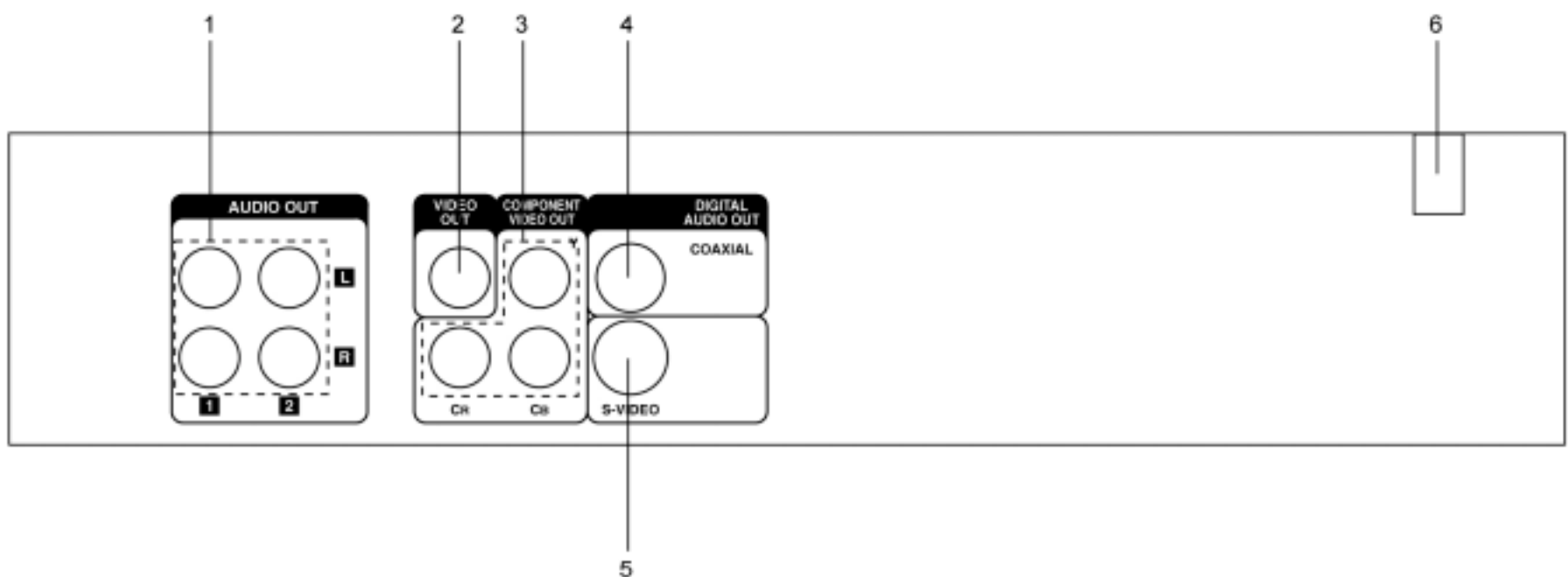

① AUDIO OUT

④ COAXIAL DIGITAL OUT

② VIDEO OUT

⑤ S-VIDEO OUT

③ COMPONENT VIDEO OUT

⑥ POWER SUPPLY CORD

I. PREPARATIONS BEFORE OPERATION

NAMES AND LAYOUT OF REMOTE CONTROLS

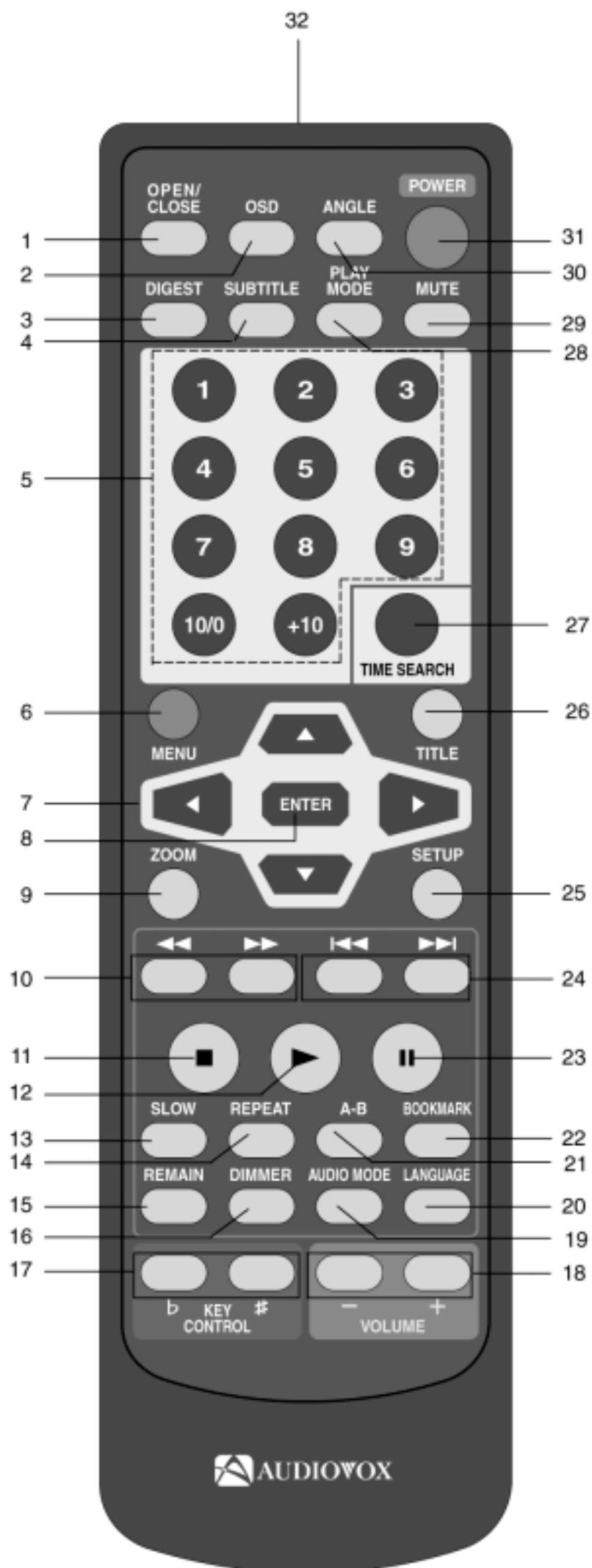

- ① OPEN/CLOSE
- ② OSD
- ③ DIGEST
- ④ SUBTITLE
- ⑤ NUMBER BUTTONS
- ⑥ MENU
- ⑦ DIRECTIONS
- ⑧ ENTER
- ⑨ ZOOM
- ⑩ FR/FF SEARCH
- ⑪ STOP
- ⑫ PLAY
- ⑬ SLOW
- ⑭ REPEAT
- ⑮ REMAIN
- ⑯ DIMMER
- ⑰ KEY CONTROL
- ⑱ VOLUME+, -
- ⑲ AUDIO MODE
- ⑳ LANGUAGE
- ㉑ A-B
- ㉒ BOOKMARK
- ㉓ PAUSE
- ㉔ PREVIOUS/NEXT
- ㉕ SETUP
- ㉖ TITLE
- ㉗ TIME SEARCH
- ㉘ PLAY MODE
- ㉙ MUTE
- ㉚ ANGLE
- ㉛ POWER
- ㉜ REMOTE TRANSMITTER

I. PREPARATIONS BEFORE OPERATION

CONNECTIONS

Turn off all the equipment before operation.

The unit has many kinds of output modes like A/V output, S-VIDEO output, Component Video output, digital signal output (COAXIAL). You may select as you need.

CONNECTED TO A TV

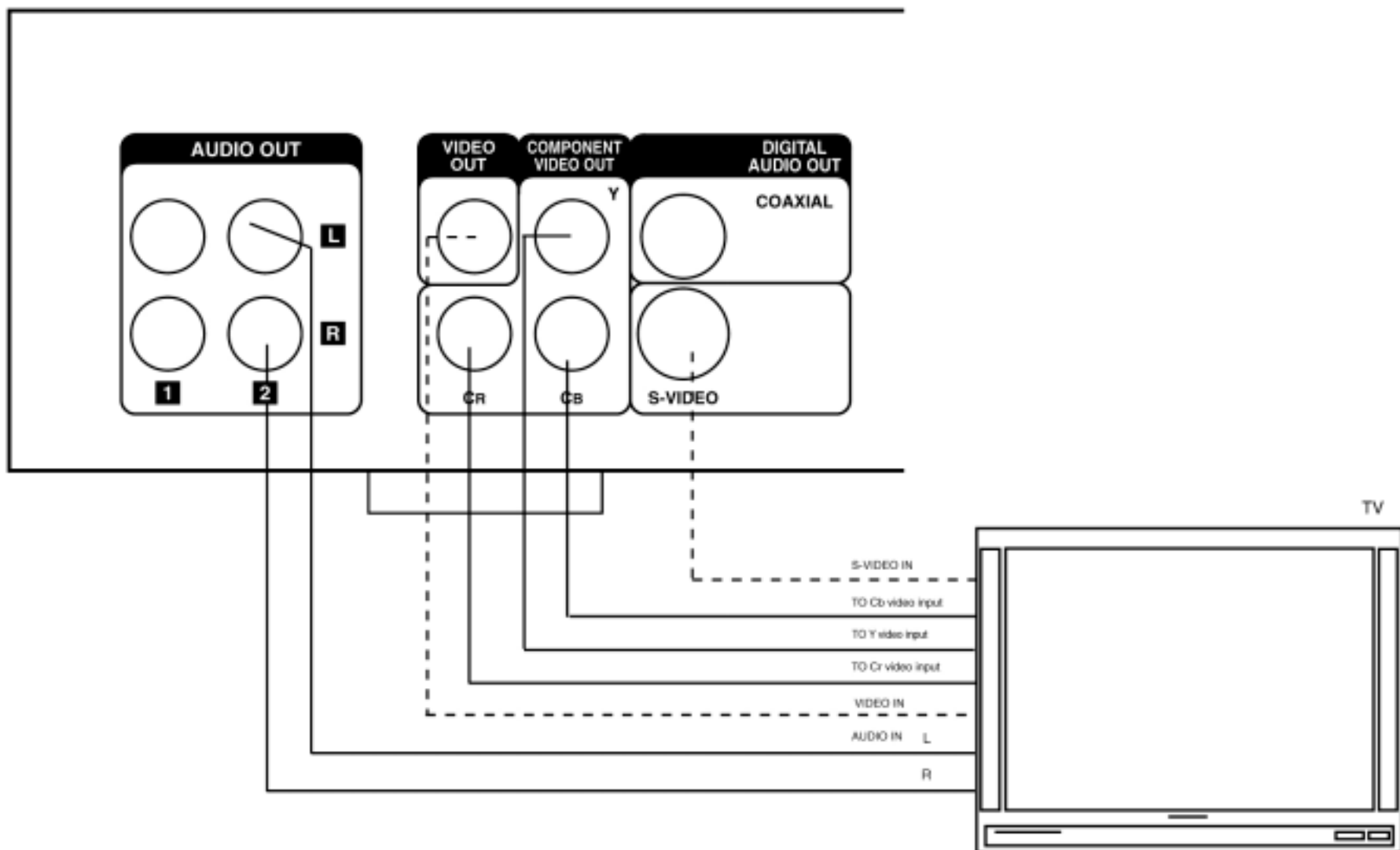

1. If the TV has Component Video input, please connect the unit and the TV with Component Video cord (not supplied). You do not have to connect it to S-VIDEO. Component Video will ensure clearer image.
2. Set the unit. You have to set the unit according to the TV to be connected.
 - Connect the unit to a wide-screen TV.
Set the "TV DISPLAY" to " WIDE " in the function setting column.
 - Connect the unit to an ordinary TV.
Set the "TV DISPLAY" to "NORMAL/PS" or "NORMAL/LB" in the function setting column.

I. PREPARATIONS BEFORE OPERATION

CONNECT TO AN ORDINARY AMPLIFIER

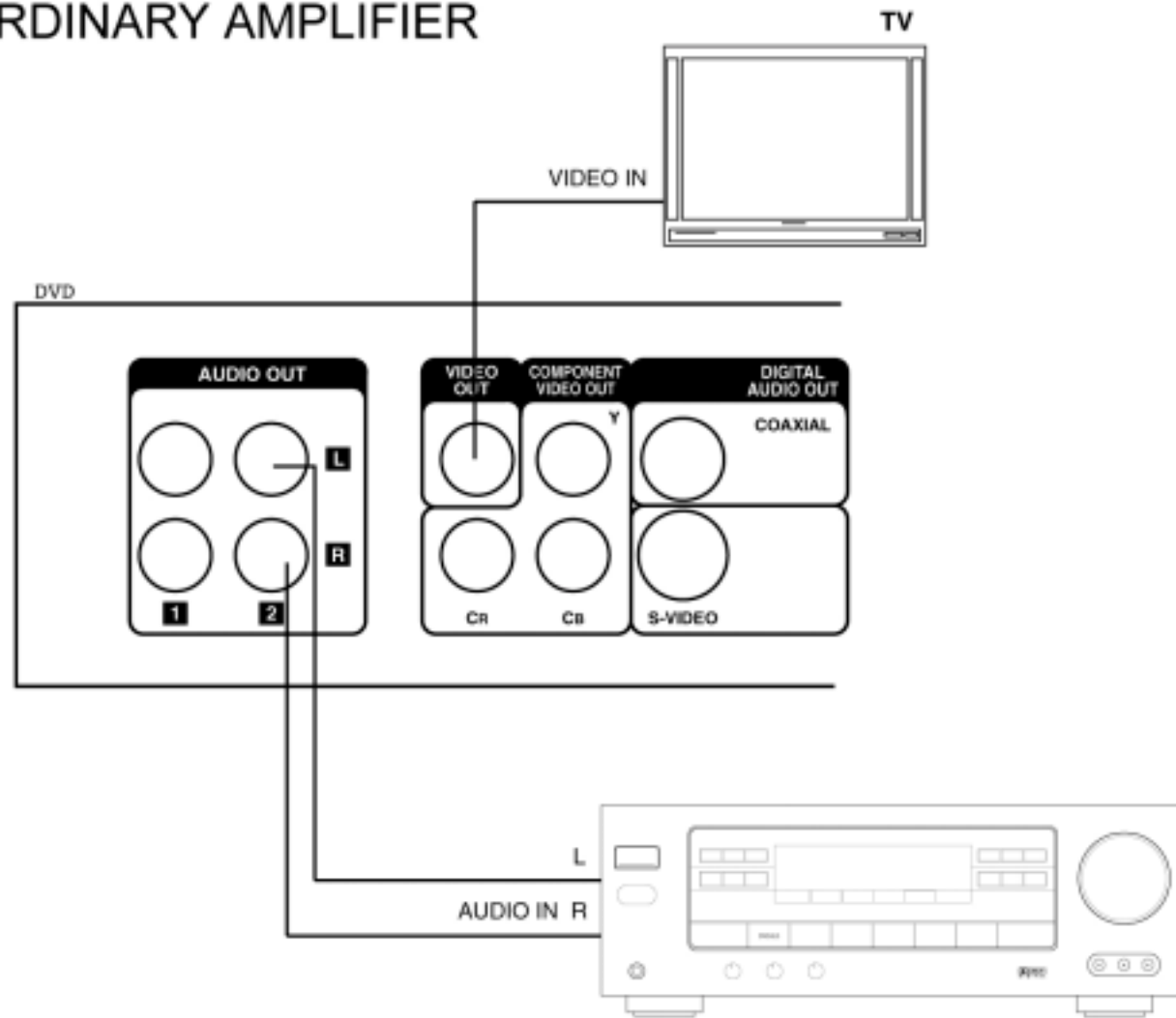

⦿ There is no sound output from the output terminal when a DTS disc is played.

CONNECT TO AN AMPLIFIER WITH DIGITAL SIGNAL INPUT

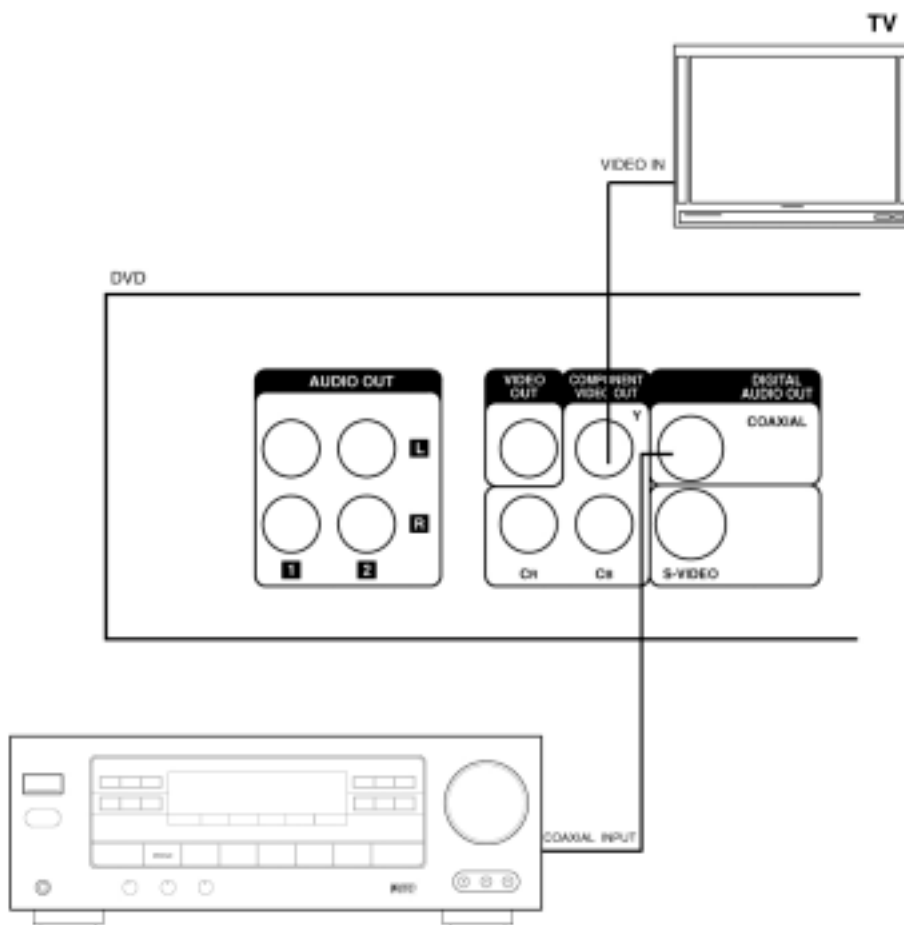

Manufactured under license from Dolby Laboratories. "Dolby" and the double-D symbol are trademarks of Dolby Laboratories. Confidential Unpublished works. ©1992-1997 Dolby Laboratories, Inc. All rights reserved.

"DTS" and "DTS Digital Out" are trademarks of Digital Theater Systems, Inc.

⦿ If you have DTS decoder or processor, you can enjoy DVD disc or CD sound decoded by 5.1 channel DTS.

J. BASIC OPERATIONS

TV/AUDIO SELECTION

Press **POWER** on the TV and audio system.

1. Press "TV/VIDEO" on the TV, select VIDEO mode (TV).

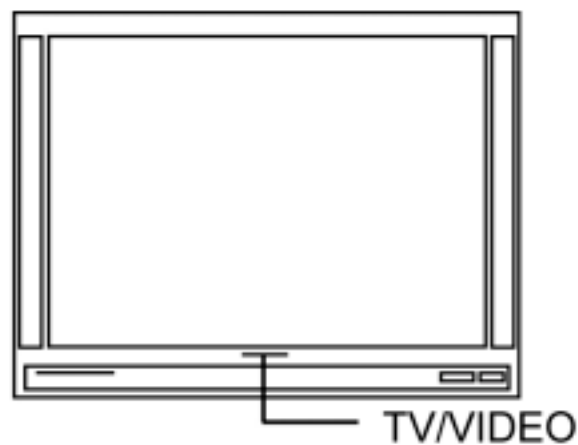

- Select S-VIDEO mode to connect to S-VIDEO. (if available)
2. Select the correct audio input on the amplifier.
- Each amplifier is different from another, please refer to the manual of the amplifier. (e.g., connect the audio output of the DVD player to the DVD audio input of an amplifier.)

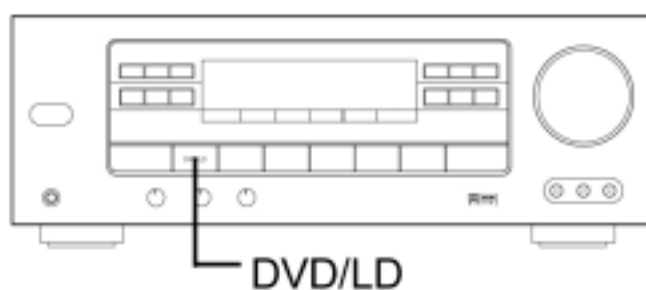

Note: This step can be cancelled if you do not connect it to the amplifier.

PLAY DISCS

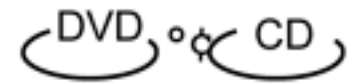

1. Press **POWER** to turn on the unit.

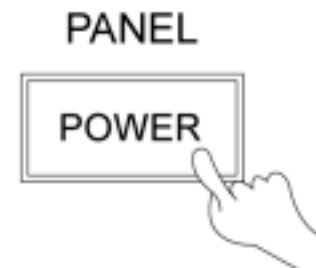

2. Press **▲** on the front panel to open the disc tray and load a disc with the label side up.

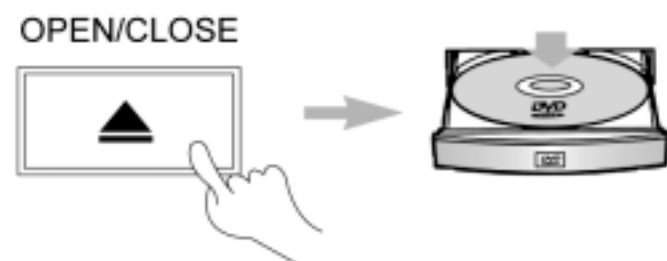

3. Press **▲** again to close the disc tray. The unit begins to read the disc.

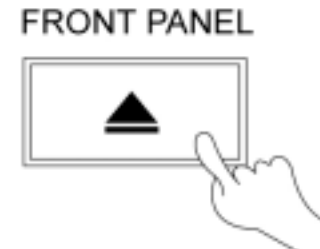

4. Press **▶** (PLAY) to play the disc.

AFTER STEP 4 IS FINISHED:

- **PLAY DVD**
The TV screen shows DVD menu or title menu.
 - **PLAY CD**
Press **▶** (PLAY), the unit plays the disc according to the track numbers.
5. Stop playback.
Press **◻**.



6. Remove the disc and cut off the unit.
 - You have to push "◻" button twice to stop playback of a DVD disc.



J. BASIC OPERATIONS

PAUSE

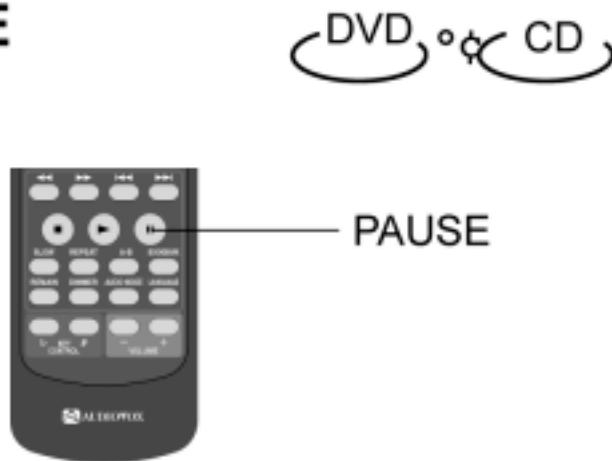
Press 





◦ WHEN PLAYING PICTURES

If the pictures of DVD are played, press  to make playback pause. The unit enters step play status. Each time you press , the picture advances one frame.





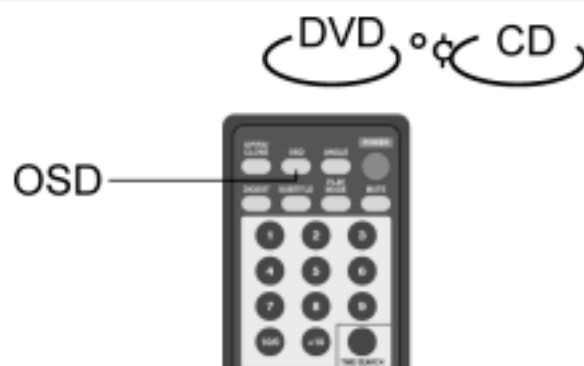

◦ WHEN PLAYING MUSIC CD

Press  to make playback pause.
Press  (PLAY) to resume playback.

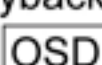
OSD



The On-Screen Display (OSD) contains many playback features. To see the Display, press the  button on the remote while a disc is playing. The Display appears across the top of the screen. Each feature is illustrated with an icon. Use the  or  buttons on the remote to move through the different icons in the Display.

When an icon is highlighted, use the  or  buttons on the remote to scroll through the choices displayed in the text box under the icons.

Remember, you can only access the Display when you're playing a disc. Also, the Display features are only available if the disc was created with that particular feature (i.e., if you select the Subtitle icon, you won't be able to change the subtitle language unless the author of the disc created the disc with subtitles).





The invalid symbol "⊘" appears on the screen when you press a button that doesn't have any function. If one of the icons is "grayed out", that Display feature isn't available for the disc you're playing. To make the Display disappear from the screen, press OSD on the remote.

WHEN PLAYING DVD

DVD discs have the following playback features: Title, Chapter, Audio, Subtitle, Angle and Repeat.

◦ Select a Title

Some discs contain more than one title. For example, there might be four movies on one disc (each movie might be considered a title). Each title is divided into chapters. To select a title:

1. While the disc is playing, press  on the remote to bring up the Display.
2. If the Title icon on the Display isn't highlighted, use the  or  buttons to highlight it.
3. Press the  or  buttons to go to the previous or next title.

Note: Some discs only have one title.

◦ Select a Chapter

Because DVD discs use digital technology, a title can be divided into individual chapters (similar to tracks on a CD). You can skip to a specific chapter by using the Chapter feature in the Display.

1. While the disc is playing, press  on the remote to bring up the Display.

J. BASIC OPERATIONS

2. Press the ◀ or ▶ buttons to highlight the Chapter icon.
3. Press the ▲ or ▼ buttons to go to the previous or next chapter.

Notes: The chapter feature won't work if the disc isn't formatted with separate chapters. You can also advance to the next chapter by pressing ▶▶ on the remote and go to the preceding chapter by pressing ◀◀ on the remote.

◦^ Changing the Audio Language

If the disc was created with different language tracks (recorded in different languages), you can use the Display to temporarily change the DVD player's Audio Language setting.

1. While the disc is playing, press **OSD** on the remote to bring up the Display.
2. Press the ◀ or ▶ buttons to highlight the Audio icon. The current audio language appears in the text box below the row of icons.
3. Press the ▲ or ▼ buttons to scroll through the audio languages that are available on the disc until the audio language you want to use appears in the text box. Audio will be played in that language.
4. To make the Display disappear, press the **OSD** button on the remote.

Note: The language feature only works if the disc was created with multiple audio tracks. When you choose an audio language from the Display, you only override the audio language setting in the DVD player's main menu temporarily.

The audio language can also be changed through the DVD player menu.

◦^ Selecting the Subtitle Language

If the disc was created with subtitles, you can use the Display to change the Subtitle language.

1. When the disc is playing, press **OSD** on the remote to bring up the Display.
2. Press the ◀ or ▶ buttons to highlight the Subtitle icon.
3. Press the ▲ or ▼ buttons to scroll through the subtitle languages that are available on the disc until the subtitle language you want to use appears in the text box. The subtitles will be shown in that language.
4. To make the Display disappear, press the **OSD** button on the remote.

Notes: Changing the subtitle language with the Display will only affect the disc currently being played. When the disc is removed or the player is turned off, the subtitle language will revert to the language setting specified through the DVD player main menu.

The subtitle language can also be changed through the DVD player menu.

◦^ Changing the Camera Angle

Some discs contain multiple angles of a particular scene or sequence. If the disc only has one angle, this feature won't work. When multiple angles are available, to change the camera angle:

1. When a disc is playing, press **OSD** on the remote to bring up the Display.
2. The Angle icon will display the number of angles available. For example, if there are 3 different angles, the icon will read 1 of 3. This means angle 1 is currently being played.
3. Press the ▲ or ▼ buttons to scroll through the angle choices. The angle number displayed in the text window is automatically shown.
4. To make the Display disappear, press the **OSD** button on the remote.

◦^ Using the Repeat Feature

The default mode for the Repeat feature is off. There are three Repeat options:

J. BASIC OPERATIONS

- °§ All-repeats the disc that is playing
- °§ Title-repeats the title that is playing
- °§ Chapter-repeats the chapter that is playing

To Use Repeat:

1. While a disc is playing, press **[OSD]** on the remote to bring up the Display.
2. Highlight the Repeat icon.
3. Press the **▲** or **▼** buttons to scroll through the Repeat options until the Repeat option you want is displayed in the text box.
4. The selected repeat option will loop repeatedly until you turn Repeat off.

How to Cancel Repeat:

There are three ways to cancel Repeat:

- °§ Press STOP twice.
- °§ Go to Repeat icon in the Display and select Off.
- °§ Eject the disc.

WHEN PLAYING CD

CD discs have the following playback features: Track, L/R, Audio (not available) and Repeat.

°^ Select a Specific Track

1. While the disc is playing, press **[OSD]** on the remote to bring up the Display.
2. Highlight the Track icon.
3. Press the **▲** or **▼** buttons to scroll through the track numbers.

°^ Changing the Audio Channel Output

If you are playing a Stereo CD, you can change the channel output from the player.

1. Press **[OSD]** on the remote to bring up the Display.
2. Highlight the L/R icon on the Display.
3. The audio channel choices appear in the text box. Press the **▲** or **▼** buttons to scroll through the choices: LEFT MONO, RIGHT MONO, MIXED MONO or STEREO. Whatever choice is displayed becomes the active choice.

°^ Using the Repeat Feature

The default mode for the Repeat feature is off. There are two Repeat options for CDs:

- °§ All-repeats the disc that is playing
- °§ Track-repeats the track that is playing

To Use Repeat:

1. While a disc is playing, press **[OSD]** on the remote to bring up the Display.
2. Highlight the Repeat icon.
3. Press the **▲** or **▼** buttons to scroll through the Repeat options until the Repeat option you want is displayed in the text box.
4. The selected repeat option will loop repeatedly until you turn Repeat off.

VOLUME CONTROL

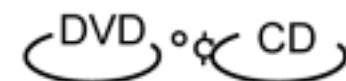

- ° Press **[VOLUME]** on the TV or amplifier to adjust the volume.
- ° Press **[VOLUME]** on the remote control.



VOLUME+,-

1. Press **[+]** to raise the volume.



2. Press **[-]** to lower the volume.

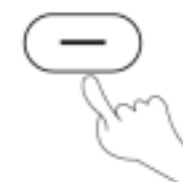

J. BASIC OPERATIONS

DVD MENU PLAY

some DVDs have title menus and chapter menus.

Press ►(PLAY), the screen shows the menu.
Press ►► or ◀◀ to skip the next or previous page, select with number buttons or direction buttons.

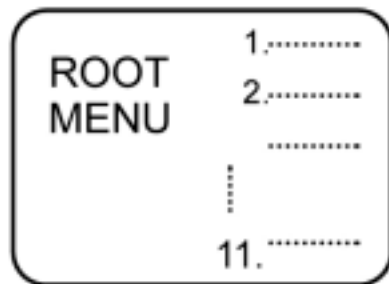

Example: select track 13.

1. Press ►► to enter the next menu.

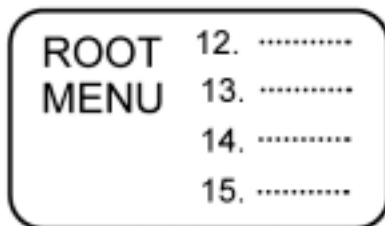

2. Press number buttons to select directly.

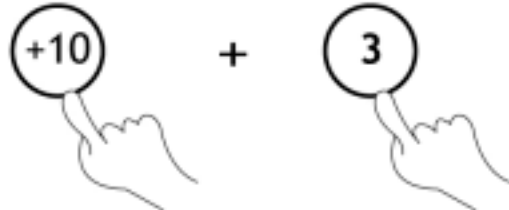

You can also do as follows:

1. Press ▼ to select track 13.



2. Press ► (PLAY) to start playing track 13.

Press **TITLE** once to return to the title menu.
Press **MENU** once to return to the root menu.

SELECT WITH NUMBER BUTTONS

Load a disc. Press number buttons to select tracks after the unit finishes reading the disc.

1. If the track number isn't over 10, just push buttons 1-10.

Example: push **8** to select track 8.

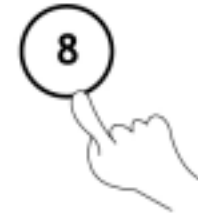

The screen shows:

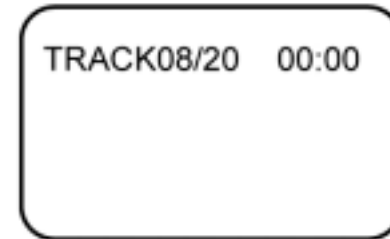

2. If the track number is over 10, press **+10** once and a button among 1-10.

Example: if you select track 12, press **+10** once and button **2**.

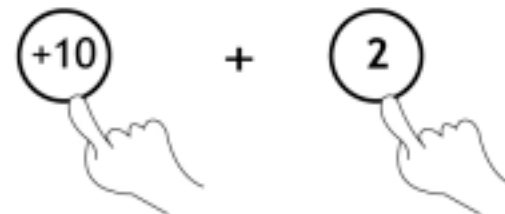

The screen shows:

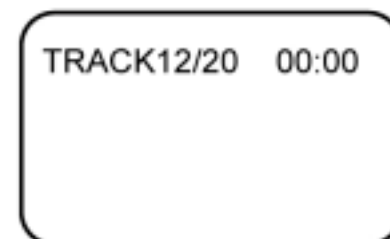

K. PLAY DISCS IN VARIOUS WAYS

AUDIO MODE



- You may select a needed language from a multi-language DVD .
- You may select the right channel or left channel or stereo from a multi-channel CD.

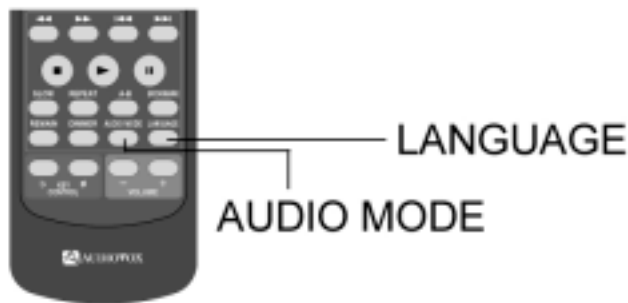

WHEN PLAYING DVD

- Press LANGUAGE, the screen shows orderly:

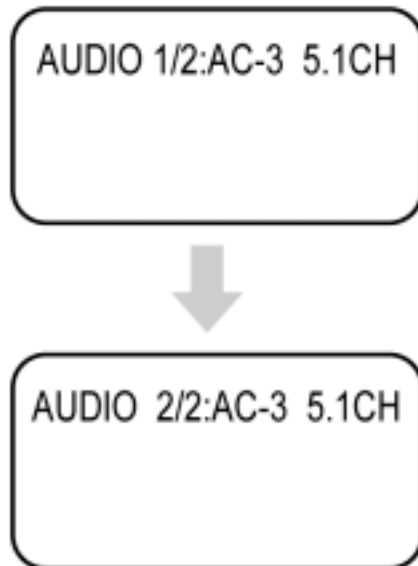

Different discs differ in languages.

- Press **AUDIO MODE** , the screen shows orderly:

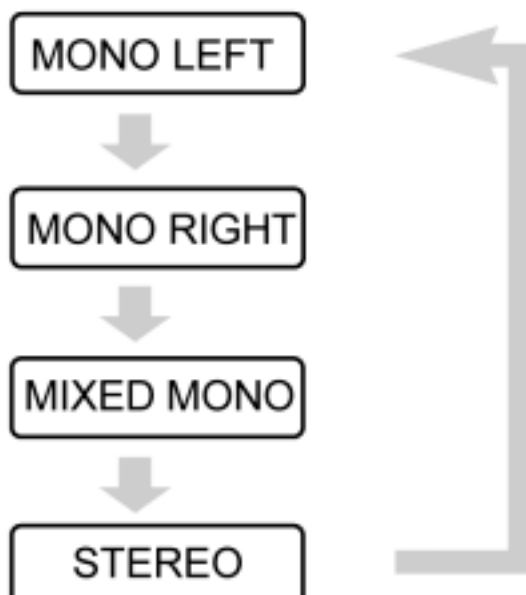

WHEN PLAYING CD

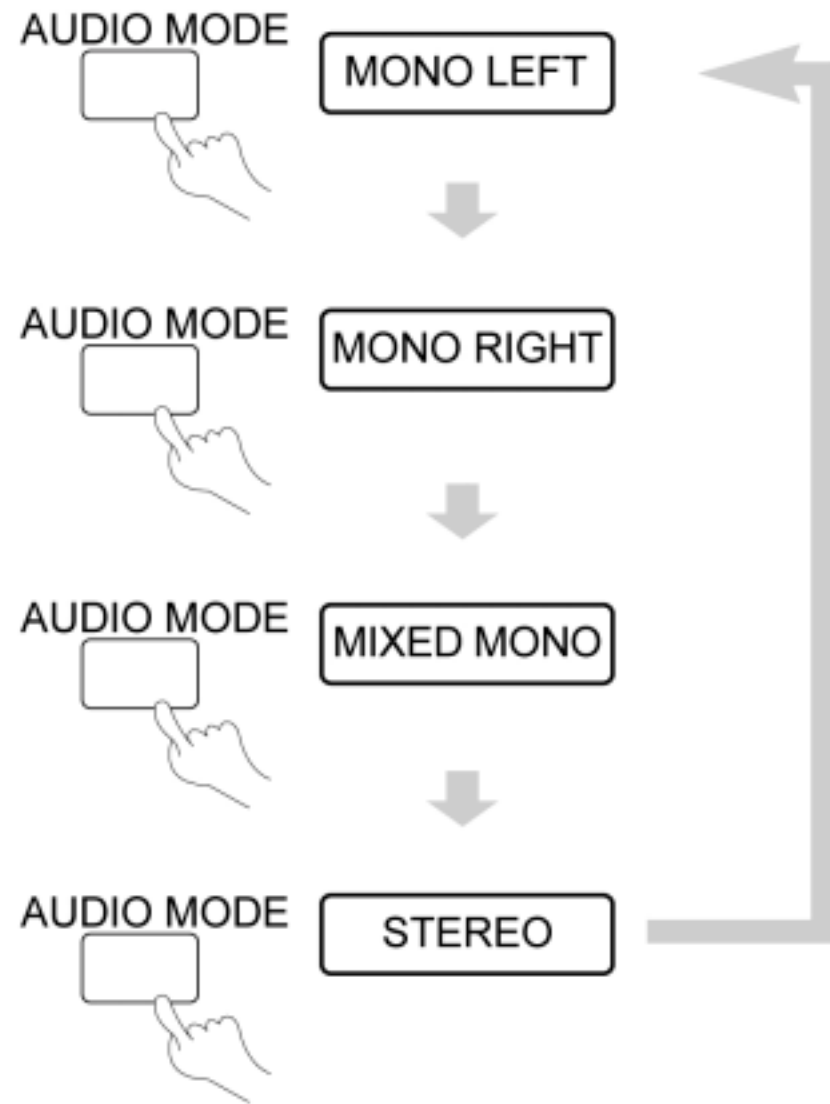

You may select one mode.

Notes:

- Different discs differ in languages.

MUTE



When playing a disc, this function can remove the sound.

1. REMOVE SOUND

Press **MUTE** , the screen shows "MUTE".



2. RESUME SOUND

Press **MUTE** again, the screen shows "MUTE OFF".

K. PLAY DISCS IN VARIOUS WAYS

FAST PLAY

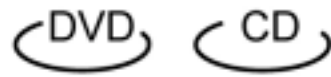

When playing a disc, you may play it forward fast or reverse it fast to find what you want.

WHEN PLAYING DVD OR CD

1. Press **▶▶** to play forward fast. Each time you press the button, the screen shows orderly:

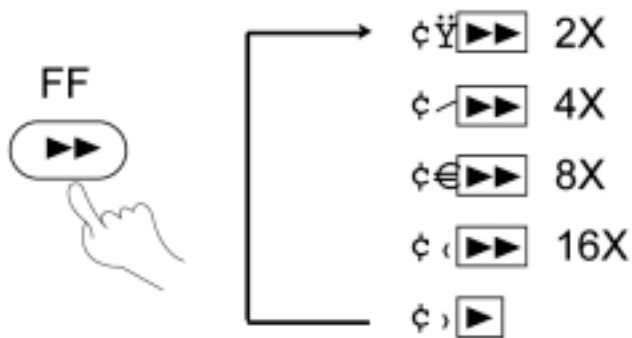

2. Press **◀◀** to reverse the disc fast. Each time you press the button, the screen shows orderly:

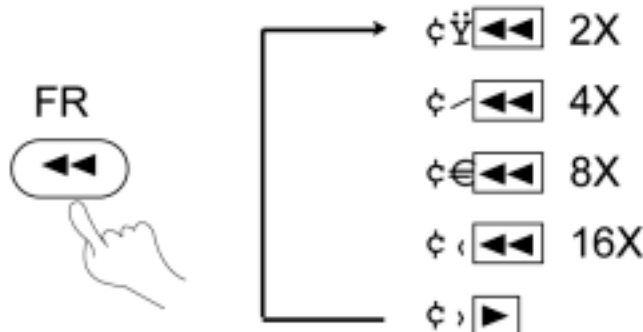

3. Press **▶** (PLAY) to switch to normal play while FF or FR playing.

SLOW PLAY



Enjoy slow motions by the following steps.



WHEN PLAYING DVD

1. Press SLOW to play slowly.



The screen shows orderly:



2. Press **▶** (PLAY) to play normally.

K. PLAY DISCS IN VARIOUS WAYS

REPEAT PLAY



This function can be used to repeatedly play a title, chapter, track, disc, or some part on a disc.



PLAYING A DISC REPEATEDLY

°^ DVD

You may repeat a title or chapter.

1. Repeat a chapter.

Press **REPEAT**, the screen will show



2. Repeat a title

Press **REPEAT** twice, the screen will show



3. Repeat all.

Press **REPEAT** third time, the screen shows " ALL".

4. Remove "REPEAT" function.

Press **REPEAT** until " ALL" disappears.

°^ CD

° You may repeat a track, a disc according to the following steps.

1. Repeat a track.

Press **REPEAT**, the screen shows " TRACK". The unit plays the current track.

REPEAT

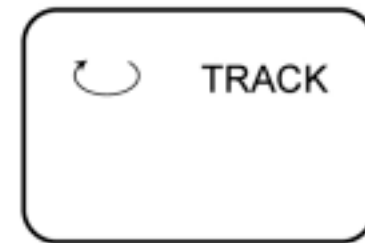

2. Repeat a disc.

Press **REPEAT**, the screen shows " ALL". The unit plays all the tracks on the disc.

REPEAT



3. Remove "REPEAT" function.

Press **REPEAT** till " ALL" disappears.

REPEAT SOME PARTS

You may press **A-B** to enjoy some parts repeatedly when playing a disc.

°^ PLAY DVD or CD.

1. Set a starting point A.

The screen shows:



2. Set an end point B.

The screen shows:



Afterwards, the unit plays from A to B.

3. Press **A-B** again till " AB " disappears.

K. PLAY DISCS IN VARIOUS WAYS

SELECT SUBTITLES

This operation works only with discs on which multiple subtitle language are recorded.

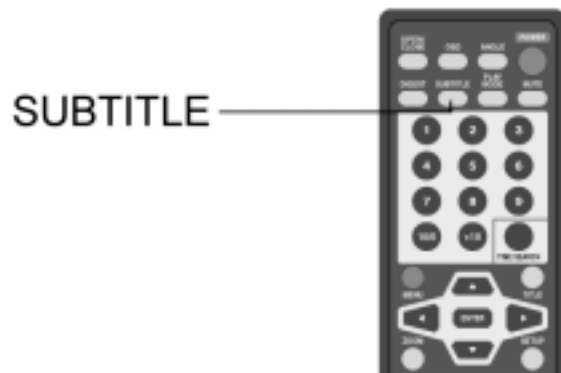

PLAY DVD

1. Press **SUBTITLE** repeatedly until the desired language is selected.

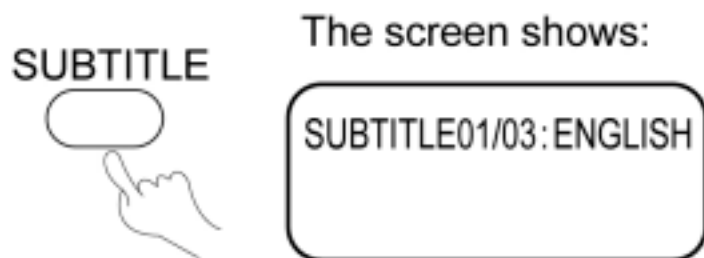

2. Remove the subtitle.

Press **SUBTITLE** until the screen shows "TURN OFF SUBTITLES".

Notes:

- For some discs, subtitles can not be removed.
- Different discs differ in the language of subtitles.
- If the subtitles of discs can not be selected, press **SUBTITLE**, the screen shows "NO SUBTITLE".

ANGLES SELECT

Some discs have images with different viewing angles, you may select among them. For example, when you watch a running train, you may watch it from the front, the left window or the right window without stopping it.

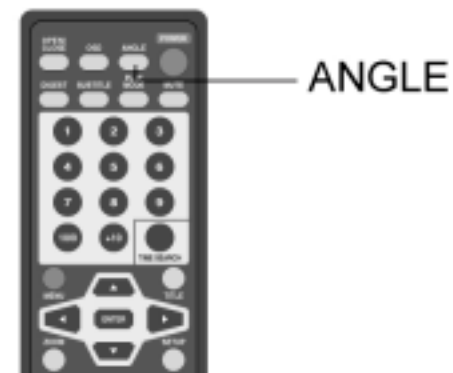

Example:

A DVD has four viewing angles at your option.

1. Press ANGLE to select ANGLE1.

SCREEN



2. Press ANGLE to select other angles, the screen shows respectively:

 2/4 (select ANGLE2)

 3/4 (select ANGLE3)

 4/4 (select ANGLE4)

3. To resume normal playback, press ANGLE to select original angle.

K. PLAY DISCS IN VARIOUS WAYS

TIME SEARCH AND REMAINING TIME

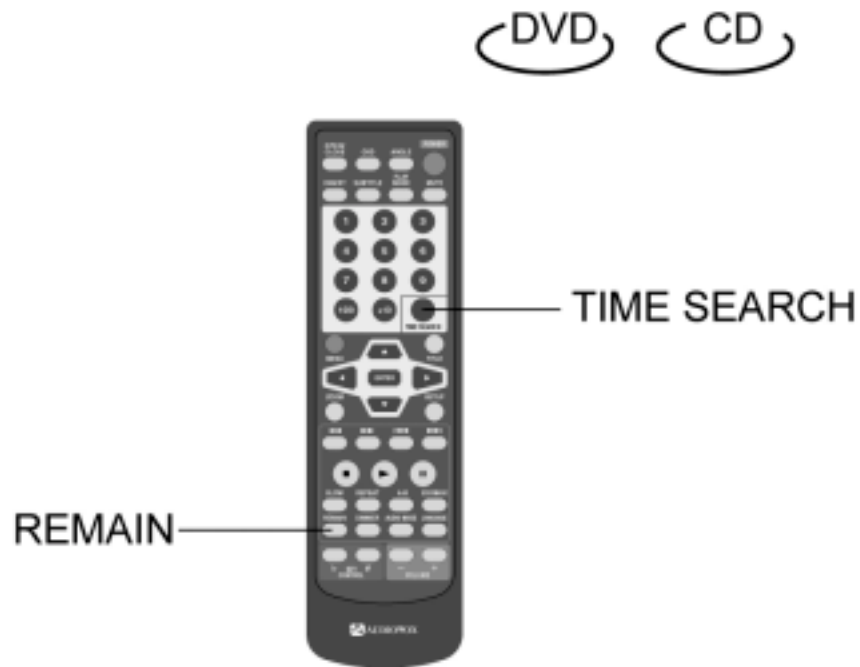

TIME SEARCH

You may directly enter a time, title or chapter number to search fast on a disc, the unit plays from that point.

°^ PLAY DVD

1. Search a title or a chapter.

Example: Search chapter 2 in title 6.

- ° Press **TIME SEARCH**, the screen shows:

TITLE03/30 CHAPTER 001 /004

- ° Press the direction button and move the cursor to illuminate the title number.

The screen shows:

TITLE 03 /30 CHAPTER001/004

- ° Press button **6** to select title 6, the screen shows:

TITLE 06 /30 CHAPTER001/004

- ° Repeat the steps above, select chapter 2 in title 6.

2. TIME SEARCH

- ° Press **TIME SEARCH** until the screen shows:

TIME ---:---:---

- ° Press number buttons to enter hour, minute and second.

Example: Enter **1,0,2,3,8**

After setting, the unit will play the disc from 1:02:38.

°^ PLAY CD

To jump to a specific time, use **TIME SEARCH** to set the time for the desired location.

Example: Play from 01:38 of track 6.

1. Press button **6** to select track 6.

The screen shows:

TRACK06/20 00:01

2. Press **TIME SEARCH** until the screen shows:

TRACK GO TO ---:---

3. Press button **0,1,3,8** to enter the time.

The screen shows:

TRACK06/20 01:38

- ° The unit plays from 01:38 of track 6 after setting.

- ° Press **10/0** to enter 0.

Note: CD discs have three options in time search function:

- ° You can enter the elapsed time of a disc to play.
- ° You can enter the elapsed time of a track to play.
- ° You can go to a track you want play by entering the track number.(Similar to title and chapter search for DVD.)

K. PLAY DISCS IN VARIOUS WAYS

REMAINING TIME

This function can be used to find the remaining time of a title, chapter, track or a disc.

°^ DVD

1. Press **REMAIN**, the screen shows the elapsed time of the title

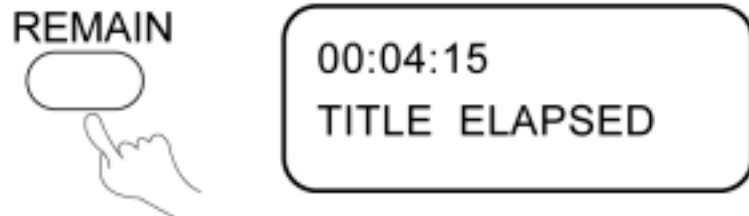

2. Press **REMAIN** again, the screen shows the remaining time of the title.



3. Press **REMAIN** third time, the screen shows time of the chapter.

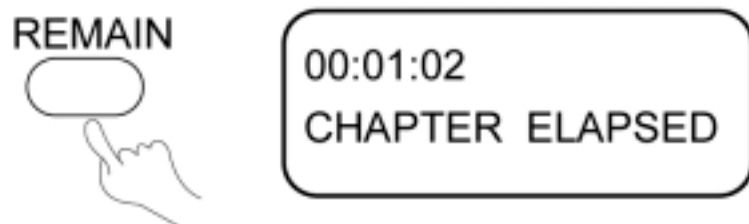

4. Press **REMAIN** fourth time, the screen shows the remaining time of the chapter.

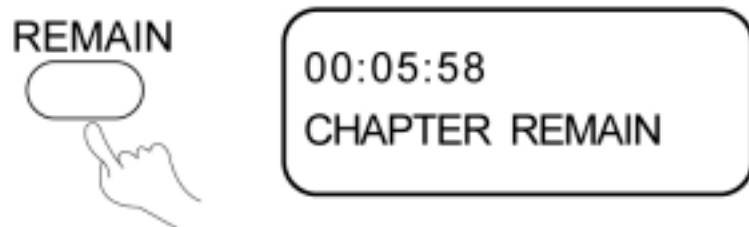

5. Press **REMAIN** once more, the screen resumes to normal play mode.

°^ CD

Example: Check the remaining time when playing track 2.

1. Press **REMAIN**, the screen shows the elapsed time of the current track.

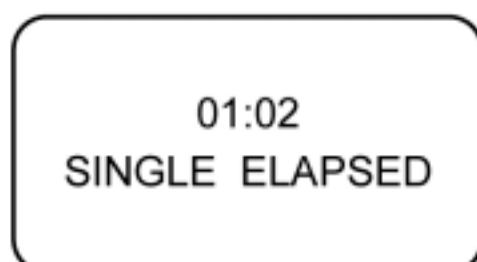

2. Press **REMAIN** again, the screen shows the remaining time of the track.

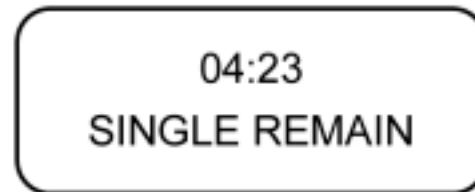

3. Press **REMAIN** third time, the screen shows the elapsed time of the disc.



4. Press **REMAIN** fourth time, the screen shows the remaining time of the disc.



5. Press **REMAIN** once more, the screen resumes to normal play mode.

BOOKMARK

DVD



BOOKMARK

The bookmark feature lets you mark a point on the disc that you can go to quickly. You can store up to 12 bookmarks per disc. When you turn the player off or remove the disc, bookmarks are cleared.

Storing a Bookmark

1. While a disc is playing, press **BOOKMARK** on the remote.
2. The Bookmark Menu appears.
3. When you reach the scene you want to mark, press **PLAY**.
4. If you want to mark another point, press the direction **▶** button to move the cursor to next spot. When you reach another scene you want to mark, press **PLAY**.
5. Press **BOOKMARK** to make the Bookmark Menu disappear from the screen and resume to normal playback.

K. PLAY DISCS IN VARIOUS WAYS

Using a Bookmark

1. While a disc is playing, press **BOOKMARK** on the remote.
2. The Bookmark Menu appears.
3. Use the direction buttons to highlight the bookmarked scene you want to activate. Press **ENTER** to go to the place you marked.

ZOOM PLAY

This function can be used to watch a motion or motionless picture.

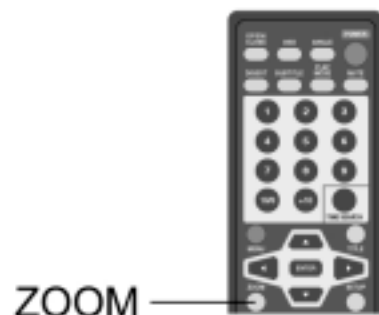

1. Press **ZOOM** during playback, the screen shows:

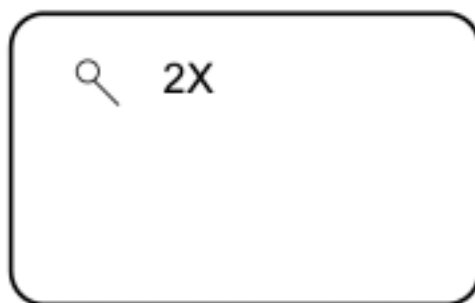

The picture is enlarged twice the size.

2. Press **ZOOM** again, the screen shows:



The picture is enlarged three times the size.

Note: The unit has six zoom steps:

2X, 3X, 4X, 1/2, 1/3, and 1/4.

3. Push **◀**, **▲**, **▼**, **▶** to move the enlarged picture.
4. To resume the picture, push **ZOOM** until the picture is in normal size.

PROGRAM PLAY



PLAY MODE

To use the program playback feature, you must enter the order in which you want the titles (and chapters) on the DVD or the tracks on the CD to play by creating a program.

WHEN PLAYING DVD

1. Press **PLAY MODE** until the screen shows:

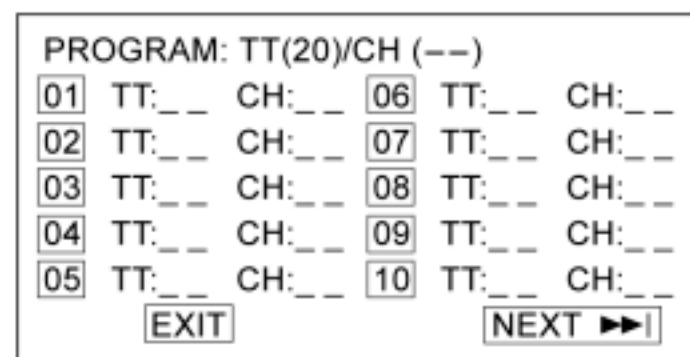

2. Use the number buttons on the remote to enter the title (and chapter) you want to play first. The title (and chapter) number you entered appears in the box. For example: Enter Chapter 1 in Title 8, the screen shows:

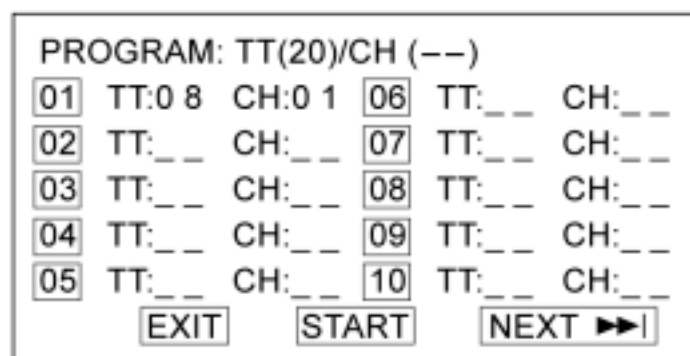

3. The cursor jumps to the next spot in the program list section.

Make sure the box is highlighted and enter your next track.

4. Continue adding titles (and chapters) until your program is complete. You can play your program by highlighting **START** and press **ENTER**.

Note: If the titles (and chapters) you want

K. PLAY DISCS IN VARIOUS WAYS

to program are more than 10, you can highlight NEXT and press **ENTER** to go to the next page.

5. To remove program playback, highlight EXIT and press **ENTER** to confirm.

WHEN PLAYING CD

1. Press **PLAY MODE** until the screen shows:

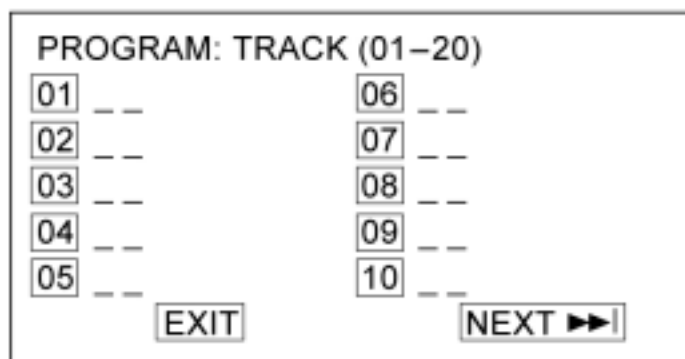

2. Use the number buttons on the remote to enter the track number you want to play first. The track number entered appears in the box. The screen shows:

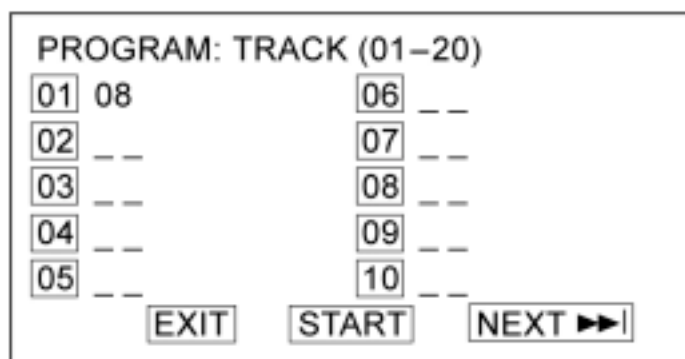

3. The cursor jumps to the next spot in the program list section. Make sure the box is highlighted and enter your next track.

4. Continue adding tracks until your program is complete. You can play your program by highlighting START and press **ENTER**.

Note: If the tracks you want to program are more than 10, you can highlight NEXT and press **ENTER** to go to the next page.

5. To remove program playback, highlight EXIT and press **ENTER** to confirm.

SHUFFLE OR RANDOM PLAY

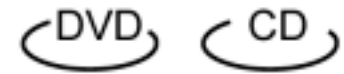

The unit can play by random orders. The order is different each time.

1. Press **PLAY MODE** to select shuffle or randomplay mode while a disc is playing.

PLAY MODE



The screen shows:

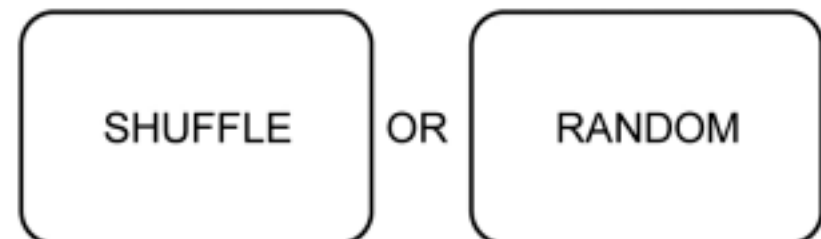

2. press **▶ (PLAY)** to start shuffle or random play.

The unit selects a track to play.

3. Remove shuffle or random play.

• When playing a DVD disc, press **◊^** twice.

• When playing a CD disc, press **◊^**.

K. PLAY DISCS IN VARIOUS WAYS

DIGEST PLAY



This function can be used to look through the content of the track or disc.



PLAYING DVD

1. Press **DIGEST** while a disc is playing.



The screen shows:

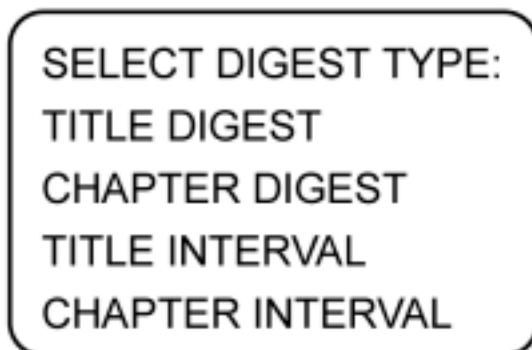

Use the ▼ or ▲ buttons to select "TITLE DIGEST" and press **ENTER** to confirm. The unit begins to look through the titles, and shows the starting picture of each title on the screen.

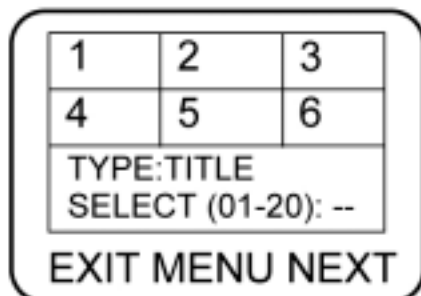

Each page has six pictures, their location may be different.

2. Use the direction buttons to select NEXT on the screen, and press **ENTER** to go to the next page.

3. To remove the digest feature, use the direction buttons to select EXIT on the screen and press **ENTER** to confirm.

Note: If you have stored bookmarks on a DVD disc, there will be one more digest option: BOOKMARK DIGEST.

PLAYING CD

1. Press **DIGEST** after the unit stops.



The screen shows:

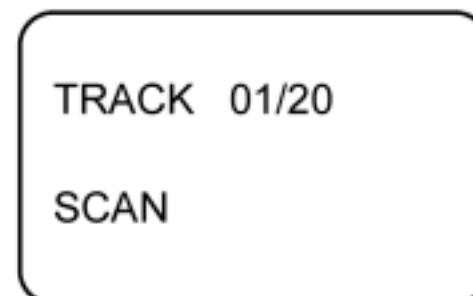

The unit plays the first ten seconds of each track one after another.

2. Remove digest play.
Press **STOP**, digest play is removed and the unit stops.



Note: A CD disc only has "SCAN" function.

L. FUNCTION SETTING

MENU SETTING



According to the recorded information and external equipment, set the following functions for the player to obtain the best playing status.



1. Press **SETUP** to set the main menu.

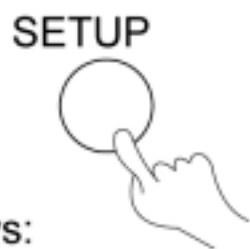

The screen shows:

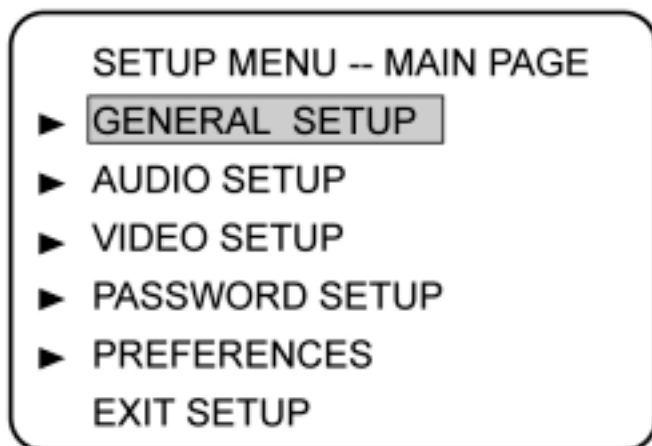

2. Press direction buttons (▶, ▲) to select and press ▶ (PLAY) to confirm.

Example: Select "AUDIO SETUP"

⦿ Press direction button ▼ to select.

The screen shows:

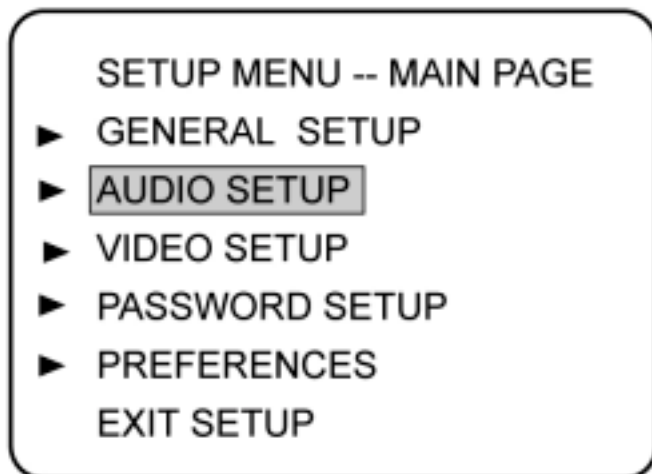

⦿ Press ▶ (PLAY) to confirm and enter "AUDIO SETUP". The screen shows the submenu for your selection.

The screen shows:

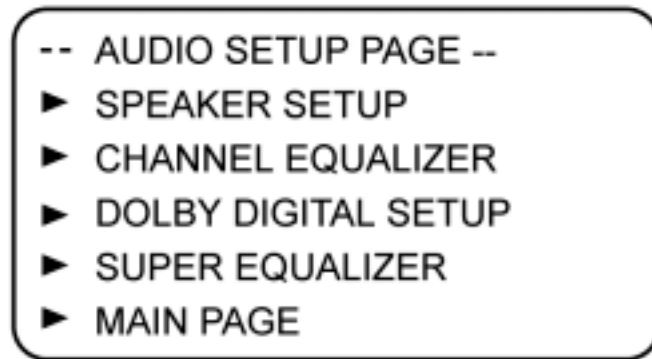

⦿ Press the ▼ button to select "DOLBY DIGITAL SETUP" and ▶ (PLAY) to confirm. The screen shows the submenu for your selection.

The screen shows:

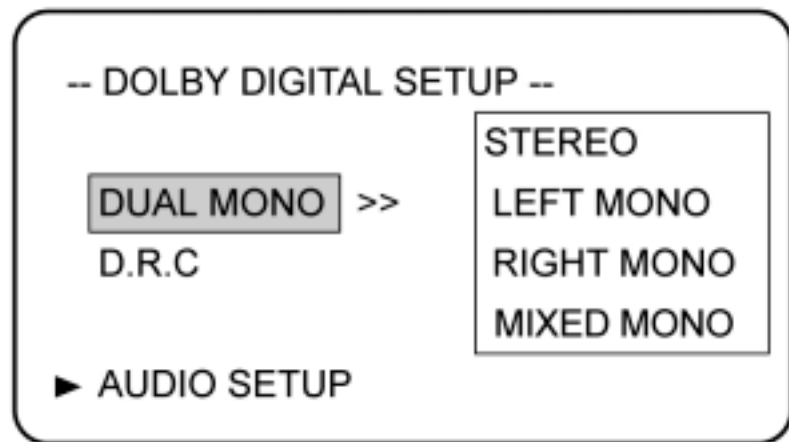

Press direction button ▶ ⌄ ▼ to select "LEFT MONO"

The screen shows:

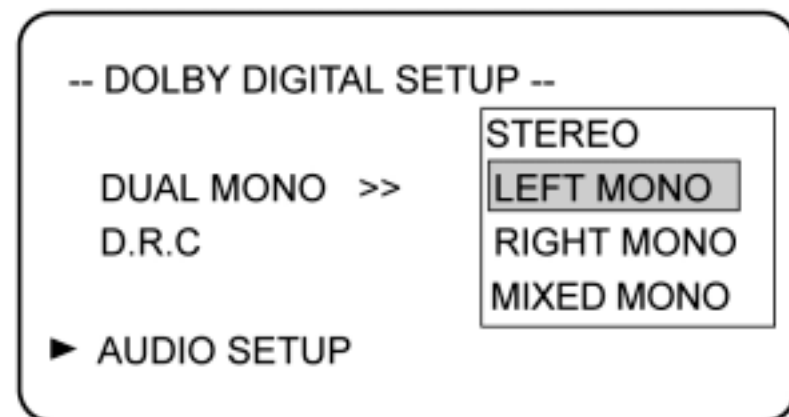

⦿ Press ▶ (PLAY) to confirm selection.



Set "DUAL MONO" in "DOLBY DIGITAL SETUP" to "LEFT MONO".

L. FUNCTION SETTING

3.Exit from menus.

Press direction buttons and ► (PLAY) to select the relevant exit column.

- Press the direction buttons ▲ ◦ ◂ to exit from "DUAL MONO".
- Press the direction button ▼ to select "AUDIO SETUP", press ► (PLAY) to exit from the current column and return to the "AUDIO SETUP PAGE".
- Press ▲, ▼ to select "MAIN PAGE", then press ► (PLAY) to return to the main menu.

GENERAL SETUP

The setting structure is as follows:

--GENERAL PAGE--

—	TV DISPLAY >>	NORMAL/PS NORMAL/LB WIDE
—	TV OUTPUT >>	YUV S-VIDEO
—	SPDIF >>	OFF SPDIF/RAW SPDIF/PCM
—	CAPTIONS >>	ON OFF
—	SCREEN SAVER >>	ON OFF
—	MENU STYLE >>	TYPE 1 TYPE 2
—	MAIN PAGE	

◦^ TV DISPLAY

1. NORMAL/PS

This is selected when the unit is connected to a normal TV.

Wide-screen images are shown on the screen, but with some parts cut automatically.



2. NORMAL/LB

This is selected when the unit is connected to a normal TV. Wide-screen images are shown on the screen, with black belt on the top and bottom.



3. WIDE

This is selected when the unit is connected to a wide-screen TV.



◦^ TV OUTPUT

1. YUV

Some TVs or monitors are equipped with component video inputs. Connecting to these inputs allows you to enjoy higher quality picture playback.

In some TVs or monitors, the color levels of the playback picture may be reduced slightly or the tint may change. In such a case, adjust the TV or monitor for optimum performance.

2. S-VIDEO

When you select this, you should connect with S-VIDEO.

L. FUNCTION SETTING

◦^ SPDIF OUTPUT

◦ SPDIF OFF: No signal is output from the coaxial port.

◦ SPDIF/RAW: Select this when the DVD player is connected with a digital amplifier through coaxial port. When a Dolby Digital disc, DTS disc or MPEG disc are played, the coaxial output will be optional. The power amplifier to be connected must have Dolby Digital, DTS and MPEG decoding.

◦ SPDIF/PCM: Select this when the DVD player is connected with a 2-channel digital stereo amplifier. When a Dolby Digital or MPEG disc is played, the coaxial port will output in PCM 2-channel format.

◦^ CAPTIONS

◦ ON

The hidden subtitle is shown.

◦ OFF

The hidden subtitle is turned off.

◦^ SCREEN SAVER

Start the screen saver, the screen saver image appears when the unit stops or the image is frozen for a few minutes. This saver can keep the screen from being damaged.

◦ ON: Start the screen saver.

◦ OFF: Remove the screen saver.

◦^ MENU STYLE

The menu has two types of styles (type 1 and type 2).

You can select one type which you like.

AUDIO SETUP

The setting structure is:

--AUDIO SETUP PAGE --

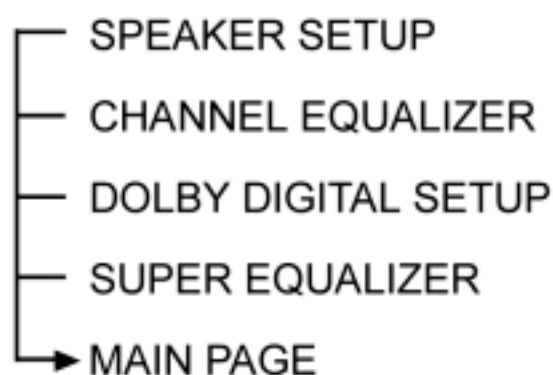

◦^ SPEAKER SETUP

The setting structure is:

-- SPEAKER SETUP PAGE --

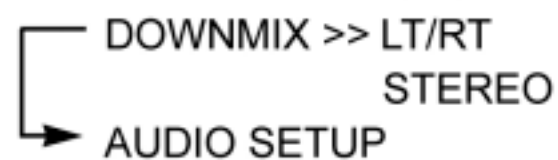

◦ LT/RT

A disc recorded multi channel soundtrack, the output signal will be incorporated to left and right channel.

◦ STEREO

A disc recorded multi channel soundtrack, the output signal will be incorporated to stereo.

◦^ CHANNEL EQUALIZER

This option will help you to select graphic equalizer patterns according to the genre of the music being played.

The setting structure is:

--CHANNEL EQUALIZER--

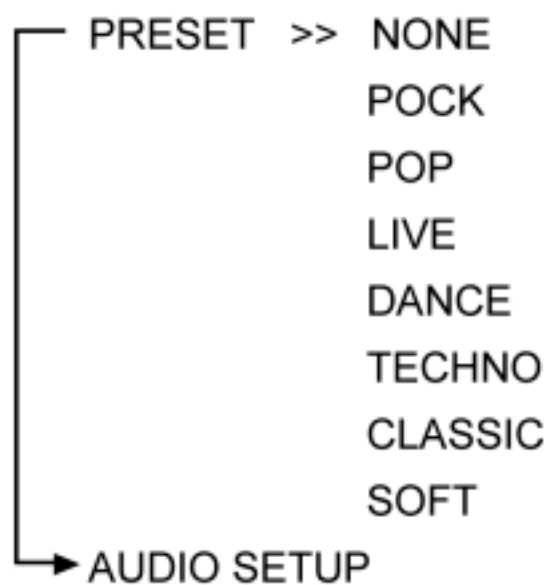

You can select music category by pressing the direction buttons and confirm by pressing the **PLAY** button.

L. FUNCTION SETTING

°^ DOLBY DIGITAL SETUP

The setting structure is:

--DOLBY DIGITAL SETUP --

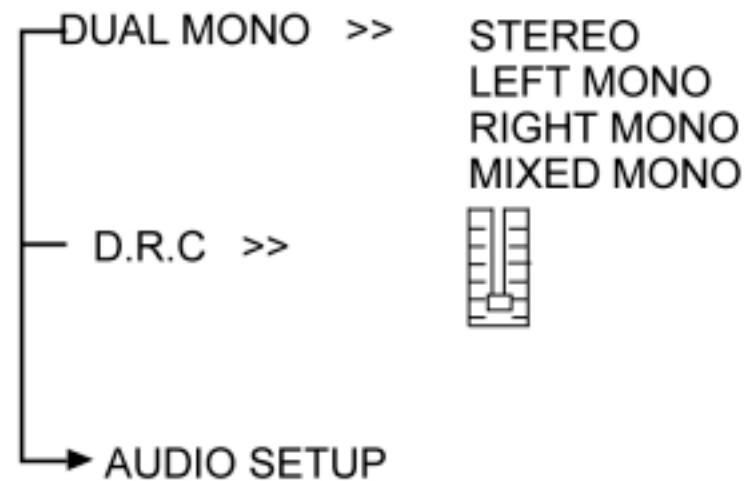

° DUAL MONO

This is the output mode of the L and R signals of the set audio output. If it is set to "MIXED MONO", the function only works when the DVD being played is 5.1-channel.

° D.R.C

This is selected to adjust linear compression rate to obtain the different compression results of the signals.

°^ SUPER EQUALIZER

This option will help you to adjust the bass equalizer.

The setting structure is:

--SUPER EQUALIZER PAGE--

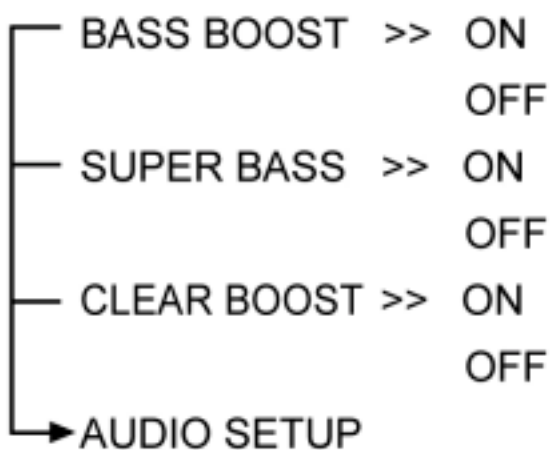

° BASS BOOST

Uses to turn BASS BOOST on and off.

° SUPER BASS

Uses to turn SUPER BASS on and off.

° CLEAR BOOST

Uses to turn CLEAR BOOST on and off.

VIDEO SETUP

The setting structure is:

--VIDEO SETUP PAGE--



°^ SHARPNESS

Uses to select the sharpness level.

° HIGH

The sharpness level is highest.

° MEDIUM

The sharpness level is medium.

° LOW

The sharpness level is lowest.

°^ BRIGHTNESS

You can use the ▲ or ▼ button to adjust the brightness.

°^ CONTRAST

You can use the ▲ or ▼ button to adjust the contrast.

L. FUNCTION SETTING

PASSWORD SETUP

The setting structure is :

```

-- PASSWORD SETUP PAGE --
├── PASSWORD >> CHANGE
├── PW MODE >> ON
│                   OFF

```

- ^ PASSWORD MODE
- ON: The password works, "PARENTAL" is dim and can not be selected.
- OFF: The password is locked, "PARENTAL" can be selected.
- ^ PASSWORD CHANGE
Select this to adapt the code, the screen shows:

```

-- PASSWORD CHANGE PAGE--
OLD PASSWORD  
NEW PASSWORD
CONFIRM PASSWORD

```

Enter a password according to the screen.

Note: The password is automatically factory set to 99999.

PREFERENCES

The setting structure is :

```

├── AUDIO >> ENGLISH
│           FRENCH
│           SPANISH
│           CHINESE
│           JAPANESE
├── SUBTITLE >> ENGLISH
│              FRENCH
│              SPANISH
│              CHINESE
│              JAPANESE
│              OFF

```

```

├── DISC MENU >> ENGLISH
│               CHINESE
│               FRENCH
│               SPANISH
│               JAPANESE
├── LOCALE >> CHINA
│            FRANCE
│            HONG KONG
│            JAPAN
│            TAIWAN
│            GBR
│            USA
├── PARENTAL >> 1. G
│              2.
│              3. PG
│              4. PG 13
│              5. PGR
│              6. R
│              7. NC-17
│              8. ADULT
└── DEFAULTS >> RESET

```

◦^ LANGUAGE SELECTION

If a language mentioned above is recorded on the disc, you can select sounds, subtitles or disc menu languages. If not, the language recorded on the disc is shown.

◦^ PARENTAL LOCK

When playing disc with parental lock function, you may select an age control grade according to grade of disc and your desire.

Example: Select "PG", you cannot play DVD video disc rated higher than the PG grade.

◦^ DEFAULT >> RESET

Each function setting returns to the initial status in the factory if you select this option.

Note:

- "PREFERENCES" only can be selected after the unit goes into stop mode.

M. MP3 OPERATION

◦^ SELECT TRACKS WITH MENU

1. Insert a disc, the unit will search disc information. The TV screen displays main menu.

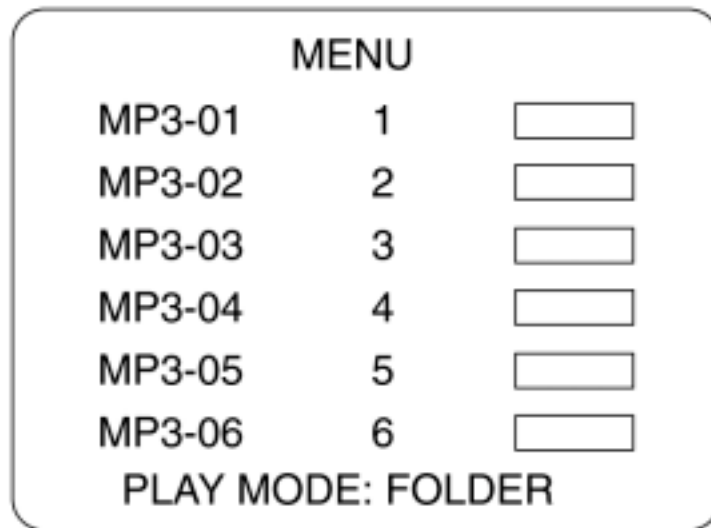

2. Press direction key ▼ to select song folder. Press ► (PLAY) to confirm selection. Example: Select MP3-02, the TV screen displays.

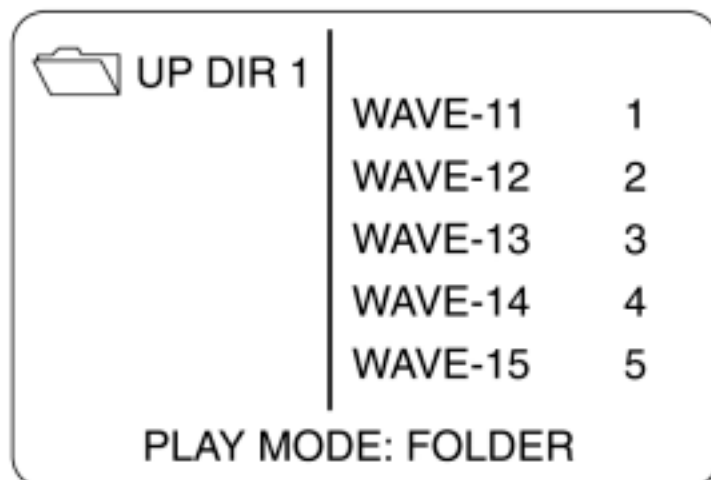

3. Press direction buttons to select a song. Press ► (PLAY) button to start playback.
4. Press ▲ or ▼ button to select other tracks in stop mode.
5. In stop mode, select the folder icon (UP DIR 1) on the left side, then press ► (PLAY) button to return to the main menu.
6. Press ►| or ◀◀ to play previous or next songs.

◦^ OTHER FUNCTIONS

During playback MP3 discs, the unit features mute, volume control, repeat play and etc. Operations are the same as CD.

N. KODAK PICTURE CD PLAYBACK

A Kodak Picture CD has the size and shape of a regular CD. You can order a KODAK Picture CD simply by checking the box on the photofinishing envelope when you drop off a roll of film (35 mm or Advanced Photo System (APS) color print film) at the time of processing in photo processing outlet displaying "Kodak Picture CD" sign. When your order is returned, you receive your prints, negatives, and your full roll of pictures safely stored on your KODAK Picture CD. Each KODAK Picture CD brings you the tools to enhance, share and manage your pictures on your computer.

Now, you can playback Kodak Picture CDs on XXX DVD players and view your pictures on your TV in the comfort of your living room.

Playing back your Kodak Picture CD

The new feature enables the decoding of JPEG files from a Kodak Picture CD disk.

Playback modes

Normal

When a Kodak Picture CD is inserted on a player an automatic slide show is launched. Each picture in the Kodak Picture CD will be displayed consecutively in a slide-show fashion and will be scaled to fit in the TV screen. Twelve slideshow transition modes are provided, use "PLAY MODE" key to select. Select transition mode prior to start of slideshow if one mode is desired for the entire show.

Mode 0: no special transition effect (by default)	Mode 8: wipe from right bottom to left top
Mode 1: wipe from left to right	Mode 9: wipe from center to top/bottom
Mode 2: wipe from right to left	Mode 10: wipe from center to left/right
Mode 3: wipe from top to bottom	Mode 11: wipe from top/bottom to center
Mode 4: wipe from bottom to top	Mode 12: wipe from left/right to center
Mode 5: wipe from left top to right bottom	Mode 13: horizontal blinds
Mode 6: wipe from right top to left bottom	Mode 14: vertical blind
Mode 7: wipe from left bottom to right top	Mode 15: random

Customer can set transition effects for each picture in a slideshow by using the "PLAY MODE" functions while viewing a slideshow. The last transition mode selected will be used in any future slideshows.

To display an image indefinitely, press the PAUSE key. To view the Next or Previous picture press NEXT or PREVIOUS keys. To resume the slideshow press the PLAY key.

Image Rotation

There are four modes to rotate a picture: "Invert", "Mirror", "Left", and "Right". These operations are allowed only when a picture is being displayed normally and will be cancelled automatically when a new picture is displayed. The arrow key is used to select the different rotation modes:

Up ▲	-Invert/Normal
Down ▼	-Mirror/Normal
Left ◀	-Turn left
Right ▶	-Turn right

Zoom

We provide both ZOOM in/out and Zoom pan function for the pictures. The "ZOOM" key is used to turn on or off this function. When this mode is on, any picture will be displayed at the last ratio selected by the user. A message on the screen will indicate the current Zoom ratio.

If zoom mode is on, "FF" and "FR" keys are used to control the ratio of zoom in/out. With ZOOM mode off, a picture is scaled to fit the TV screen.

Notes: During ZOOM function, slideshow transition and image rotation are disabled. TO cancel the ZOOM function, press the ZOOM key again and resume the slideshow.

Digest

The "MENU" or "STOP" key is used to display thumbnail size pictures. After it is enabled, up to 12 scaled-down thumbnail pictures will be displayed on the screen. The "NEXT" and "PREV" keys can be used to display the next/prev nine pictures in the the Kodak Picture CD.

You can select any of the nine displayed thumbnails by using the Arrow Keys and pressing the "ENTER" key. The thumbnail will be enlarged to fit the TV screen and the slide show will start. If you desire to display an image indefinitely, press the PAUSE key. To view the Next or Previous picture press NEXT or PREVIOUS keys. To resume the slideshow press the PLAY key.

IMPORTANT NOTE:

Quality of pictures displayed on the screen is highly dependent on the viewing device.

O. OTHERS

TROUBLE SHOOTING

If you experience the following problems while using the unit, this troubleshooting guide can help you.

◦^ **No sound**

- Check if the unit is connected securely.
- Make sure you operate the TV or amplifier correctly.
- Make sure the amplifier is set to receive DVD signal output.

◦^ **No image**

- Check if the unit is connected securely.
- Make sure you operate the TV correctly.
- Make sure you set the color system correctly.

◦^ **Bad sound quality**

- Make sure the audio output mode is set correctly.
- Make sure the audio connection between the unit and amplifier is right.

◦^ **Disc can not be played**

- There is no disc in the unit.
- Put the disc on the disc tray properly with the label side up.
- Clean the disc.
- Moisture has condensed in the unit. Remove the disc and leave the unit on for about one hour.

◦^ **The unit doesn't operate normally**

- Disconnect the power plug and insert it into the wall outlet again.

◦^ **Remote control does not work**

- Remove barriers between the remote control and the unit.
- Point the remote control at the remote control sensor of the unit.
- Replace the batteries with new ones.

O. OTHERS

TECHNICAL SPECIFICATIONS

Laser	Wavelength 650nm	
Video system	NTSC	
Frequency response	20Hz ~ 20KHz \pm 2.5dB	
Signal/noise ratio	\geq 85dB	
Audio distortion + noise	\leq - 80dB (1KHz)	
Channel separation	\geq 85dB (1KHz)	
Dynamic range	\geq 85dB (1KHz)	
Output	Audio out (analog audio)	output level: 2V \pm 10% Load impedance: 10K
	Audio out (digital audio)	output level: 0.5Vp-p \pm 20% Load impedance: 75
	Video out	output level: 1Vp-p \pm 20% Load impedance: 75 , imbalance, negative polarity
	S-video out	output level: brightness (Y) 1Vp - p \pm 20% chromaticity (C) 0.286Vp-p \pm 20% Load impedance: 75
	YUV out	Y:700mv \pm 20% Cb:535.5mv \pm 20% Cr:535mv \pm 20%
Power supply	AC120V/60Hz	
Power Consumption	\leq 20W	
Dimensions	430 \times 80 \times 260mm	
Weight	Around 3Kgs	

This manual is only for your reference, any change to the design and specifications will not be advised.



90 DAY LIMITED WARRANTY

Applies to Audiovox Video Products

AUDIOVOX ELECTRONICS CORP. (the Company) warrants to the original retail purchaser of this product that should this product or any part thereof, under normal use and conditions, be proven defective in material or workmanship within 90 days from the date of original purchase, such defect(s) will be repaired or replaced with reconditioned product (at the Company's option) without charge for parts and repair labor.

To obtain repair or replacement within the terms of this Warranty, the product is to be delivered with proof of warranty coverage (e.g. dated bill of sale), specification of defect(s), transportation prepaid, to the Company at the address shown below.

This Warranty does not extend to the elimination of externally generated static or noise, to correction of antenna problems, to costs incurred for installation, removal or reinstallation of the product, or to damage to tapes, discs, speakers, accessories, or electrical systems.

This Warranty does not apply to any product or part thereof which, in the opinion of the Company, has suffered or been damaged through alteration, improper installation, mishandling, misuse, neglect, accident, or by removal or defacement of the factory serial number/bar code label(s). THE EXTENT OF THE COMPANY'S LIABILITY UNDER THIS WARRANTY IS LIMITED TO THE REPAIR OR REPLACEMENT PROVIDED ABOVE AND, IN NO EVENT, SHALL THE COMPANY'S LIABILITY EXCEED THE PURCHASE PRICE PAID BY PURCHASER FOR THE PRODUCT.

This Warranty is in lieu of all other express warranties or liabilities. ANY IMPLIED WARRANTIES, INCLUDING ANY IMPLIED WARRANTY OF MERCHANTABILITY, SHALL BE LIMITED TO THE DURATION OF THIS WRITTEN WARRANTY. ANY ACTION FOR BREACH OF ANY WARRANTY HEREUNDER INCLUDING ANY IMPLIED WARRANTY OF MERCHANTABILITY MUST BE BROUGHT WITHIN A PERIOD OF 30 MONTHS FROM DATE OF ORIGINAL PURCHASE. IN NO CASE SHALL THE COMPANY BE LIABLE FOR ANY CONSEQUENTIAL OR INCIDENTAL DAMAGES FOR BREACH OF THIS OR ANY OTHER WARRANTY, EXPRESS OR IMPLIED, WHATSOEVER. No person or representative is authorized to assume for the Company any liability other than expressed herein in connection with the sale of this product.

Some states do not allow limitations on how long an implied warranty lasts or the exclusion or limitation of incidental or consequential damage so the above limitations or exclusions may not apply to you. This Warranty gives you specific legal rights and you may also have other rights which vary from state to state.

U.S.A. : AUDIOVOX ELECTRONICS CORPORATION, 150 MARCUS BLVD., HAUPPAUGE, NEW YORK 11788 • 1-800-645-4994

CANADA : CALL 1-800-645-4994 FOR LOCATION OF WARRANTY STATION SERVING YOUR AREA